



KenGen

KENYA ELECTRICITY GENERATING COMPANY PLC

KGN~KIP~015~2024

RFx: 5000015143

**TENDER FOR SUPPLY OF HYDRAULIC EQUIPMENT FOR
KIPEVU III POWER PLANT
(Reserved for Women Enterprises)**

Kenya Electricity Generating Company PLC
Stima Plaza Phase III, Kolobot Road, Parklands
P.O. BOX 47936-00100
NAIROBI.

Website: www.kengen.co.ke

April, 2024

INVITATION TO TENDER

PROCURING ENTITY: KENYA ELECTRICITY GENERATING COMPANY PLC

CONTRACT NAME AND DESCRIPTION: *TENDER FOR SUPPLY OF HYDRAULIC EQUIPMENT FOR KIPEVU III POWER PLANT.*

KenGen PLC invites sealed tenders from eligible candidates for the **Tender for Supply of Hydraulic Equipment for Kipevu III Power Plant**, whose specifications are detailed in the Tender Document.

Tendering will be conducted under **open tendering** method using a standardized tender document. Tendering is open to all qualified and interested Tenderers.

Tendering is exclusive to firms registered under the AGPO group (**Women Enterprises**)

Qualified and interested tenderers may obtain further information and inspect the Tender Documents during office hours between 8am and 5pm starting at the date of advert at the office of:

General Manager, Supply Chain
Tel: (254) (020) 3666000
Email: tenders@kengen.co.ke; ejuma@kengen.co.ke; tnjau@kengen.co.ke,
wkimote@kengen.co.ke;

The document can be viewed and downloaded for free from the website www.kengen.co.ke and/or on E-procurement <https://eprocurement.kengen.co.ke:50001/irj/portal> and on PPIP portal <https://tenders.go.ke>. Tenderers who download the tender document must forward their particulars immediately to (tenders@kengen.co.ke, 0711036000 and P.O.BOX 47936-00100 postal address) to facilitate any further clarification or addendum

Bidders who are unable to download the tender documents from the website may collect them from any KenGen Supply Chain Office upon payment of a non-refundable fee of **KShs.1, 000.00** paid via Mpesa, pay bill no. **400200 and account no. 01120069076000**, then share the MPesa message to KenGen Finance office staff for receipt and issuance of official receipt or through a banker's cheque and payable to the address given below.

Tender Security is **Not Applicable**. Bidders will be required to complete and sign the **Tender Securing Declaration Form** annexed to this tender document and shall be subject to authentication by KenGen.

The Tenderer shall chronologically serialize all pages of the tender documents submitted.

Completed Tender **must** be submitted **online** on or before: **7th May, 2024 at 2.00 p.m.**

Electronic submission shall be permitted through our e-procurement platform found at www.kengen.co.ke (<https://eprocurement.kengen.co.ke:50001/irj/portal>). on or before: Closing date and time

Internet Explorer and Firefox Mozilla are the preferred web browsers.

[Hard copies of the tender document **shall not be permitted**]

Late tenders will be rejected.

Tenders will be opened immediately after the deadline date and time specified above or any dead line date and time specified later. Tenders will be publicly opened in the presence of the Tenderers' designated representatives who choose to attend at the address below.

[Hard copies of the tender document **shall not be permitted**]

Late tenders will be rejected.

The addresses referred to above are:

a. Address for obtaining further information and for purchasing tender documents

Physical address for hand Courier Delivery to an office or Tender Box (City, Street Name, Building, Floor Number and Room)

Kenya Electricity Generating Company PLC
Stima Plaza Phase III, Kolobot Road, Parklands
P.O. BOX 47936-00100
tenders@kengen.co.ke ;

b. Address for Opening of Tenders.

General Manager Supply Chain
Kenya Electricity Generating Company PLC
Stima Plaza Phase III, Kolobot Road, Parklands
P.O. BOX 47936-00100
6th Floor

*KenGen adheres to high standards of integrity in its business operations.
Report any unethical behavior immediately to any of the provided anonymous hotline service.*

- 1) Call Toll Free: 0800722626;
- 2) Free-Fax: 00800 007788;
- 3) Email: kengen@tip-offs.com
- 4) Website: www.tip-offs.com

GENERAL MANAGER SUPPLY CHAIN

PART 1 ~ TENDERING PROCEDURES

1.1.1 SECTION I: INSTRUCTIONS TO TENDERERS

A General Provisions

1. Scope of Tender

1.1 The Procuring Entity as defined in the **TDS** invites tenders for supply of goods and, if applicable, any Related Services incidental thereto, as specified in Section V, Supply Requirements. The name, identification, and number of lots (contracts) of this Tender Document are specified in the **TDS**.

1.2 Throughout this tendering document:

- a) the term “in writing” means communicated in written form (e.g. by mail, e-mail, fax, including if specified in the **TDS**, distributed or received through the electronic-procurement system used by the Procuring Entity) with proof of receipt;
- b) if the context so requires, “singular” means “plural” and vice versa;
- c) “Day” means calendar day, unless otherwise specified as “Business Day”. A Business Day is any day that is an official working day of the Procuring Entity. It excludes official public holidays.

2. Fraud and Corruption

2.1 The Procuring Entity requires compliance with the provisions of the Public Procurement and Asset Disposal Act, 2015, Section 62 “Declaration not to engage in corruption”. The tender submitted by a person shall include a declaration that the person shall not engage in any corrupt or fraudulent practice and a declaration that the person or his or her sub-contractors are not debarred from participating in public procurement proceedings.

2.2 The Procuring Entity requires compliance with the provisions of the Competition Act 2010, regarding collusive practices in contracting. Any tenderer found to have engaged in collusive conduct shall be disqualified and criminal and/or civil sanctions may be imposed. To this effect, Tenders shall be required to complete and sign the “Certificate of Independent Tender Determination” annexed to the Form of Tender.

2.3 Unfair Competitive Advantage - Fairness and transparency in the tender process require that the firms or their Affiliates competing for a specific assignment do not derive a competitive advantage from having provided consulting services related to this tender. To that end, the Procuring Entity shall indicate in the **Data Sheet** and make available to all the firms together with this tender document all information that would in that respect give such firm any unfair competitive advantage over competing firms.

3. Eligible Tenderers

3.1 A Tenderer may be a firm that is a private entity, an individual, a state-owned enterprise or institution subject to ITT3.7, or any combination of such entities in the form of a joint venture (JV) under an existing agreement or with the intent to enter into such an agreement supported by a letter of intent. Public employees and their close relatives (*spouses, children, brothers, sisters and uncles and aunts*) are not eligible to participate in the tender.

In the case of a joint venture, all members shall be jointly and severally liable for the execution of the entire Contract in accordance with the Contract terms. The JV shall nominate a Representative who shall have the authority to conduct all business for and on behalf of any and all the members of the JV during the Tendering process and, in the event the JV is awarded the Contract, during contract execution. The maximum number of JV members shall be specified in the **TDS**.

3.2 Public Officers of the Procuring Entity, their Spouses, Child, Parent, Brothers or Sister. Child, Parent, Brother or Sister of a Spouse their business associates or agents and firms/organizations in which they have a substantial or controlling interest shall not be eligible to tender or be awarded a contract. Public Officers are also not allowed to participate in any procurement proceedings.

- 33 A Tenderer shall not have a conflict of interest. Any Tenderer found to have a conflict of interest shall be disqualified. A Tenderer may be considered to have a conflict of interest for the purpose of this Tendering process, if the Tenderer:
- a) directly or indirectly controls, is controlled by or is under common control with another Tenderer; or
 - b) receives or has received any direct or indirect subsidy from another Tenderer; or
 - c) has the same - representative or ownership as another Tenderer; or
 - d) has a relationship with another Tenderer, directly or through common third parties, that puts it in a position to influence the Tender of another Tenderer, or influence the decisions of the Procuring Entity regarding this Tendering process; or
 - e) or any of its affiliates participated as a consultant in the preparation of the design or technical specifications of the goods that are the subject of the Tender; or
 - f) or any of its affiliates has been hired (or is proposed to be hired) by the Procuring Entity or Procuring Entity for the Contract implementation; or
 - g) would be providing goods, works, or non-consulting services resulting from or directly related to consulting services for the preparation or implementation of the project specified in the TDS IIT 1.1 that it provided or were provided by any affiliate that directly or indirectly controls, is controlled by, or is under common control with that firm; or has a close business or family relationship with a professional staff of the Procuring Entity (or of the project implementing agency, who: (i) are directly or indirectly involved in the preparation of the tendering document or specifications of the Contract, and/or the Tender evaluation process of such Contract; or (ii) would be involved in the implementation or supervision of such Contract unless the conflict stemming from such relationship has been resolved in a manner acceptable to the Procuring Entity throughout the Tendering process and execution of the Contract.
- 34 A tenderer shall not be involved in corrupt, coercive, obstructive, collusive or fraudulent practice. A tenderer that is proven to have been involved in any of these practices shall be automatically disqualified.
- 35 A firm that is a Tenderer (either individually or as a JV member) shall not submit more than one Tender, except for permitted alternative Tenders. This includes participation as a subcontractor. Such participation shall result in the disqualification of all Tenders in which the firm is involved. A firm that is not a Tenderer or a JV member, may participate as a subcontractor in more than one Tender. Members of a joint venture may not also make an individual tender, be a subcontractor in a separate tender or be part of another joint venture for the purposes of the same Tender.
- 36 A Tenderer may have the nationality of any country, subject to the restrictions pursuant to ITT3.9. A Tenderer shall be deemed to have the nationality of a country if the Tenderer is constituted, incorporated or registered in and operates in conformity with the provisions of the laws of that country, as evidenced by its articles of incorporation (or equivalent documents of constitution or association) and its registration documents, as the case may be. This criterion also shall apply to the determination of the nationality of proposed subcontractors or sub consultants for any part of the Contract including related Services.
- 37 A Tenderer that has been debarred by the PPRA from participating in public procurement shall be ineligible to tender or be awarded a contract. The list of debarred firms and individuals is available from the PPRA's website www.ppra.go.ke
- 38 Tenderers that are state-owned enterprises or institutions may be eligible to compete and be awarded a Contract(s) only if they are (i) a legal public entity of the state Government and/or public administration, (ii) financially autonomous and not receiving any significant subsidies or budget support from any public entity or Government, and (iii) operating under commercial law and vested with legal rights and liabilities similar to any commercial enterprise to enable it compete with firms in the private sector on an equal basis. Public employees and their close relatives are not eligible to participate in the tender.
- 39 Tenderers may be ineligible if their countries of origin (a) as a matter of law or official regulations, Kenya prohibits commercial relations with that country, or (b) by an act of compliance with a decision of the United Nations Security Council taken under Chapter VII of the Charter of the United Nations, Kenya prohibits any import of goods or contracting for supply of goods or services from that country, or any payments to any country, person, or

entity in that country. A tenderer shall provide such documentary evidence of eligibility satisfactory to the Procuring Entity, as the Procuring Entity shall reasonably request.

- 3.10 Tenderers shall provide the qualification information statement that the tenderer (including all members of a joint venture and subcontractors) is not associated, or have been associated in the past, directly or indirectly, with a firm or any of its affiliates which have been engaged by the Procuring entity to provide consulting services for the preparation of the design, specifications, and other documents to be used for the procurement of the goods under this Invitation for tenders.
- 3.11 Where the law requires tenderers to be registered with certain authorities in Kenya, such registration requirements shall be defined in the **TDS**
- 3.12 The Competition Act of Kenya requires that firms wishing to tender as Joint Venture undertakings which may prevent, distort or lessen competition in provision of services are prohibited unless they are exempt in accordance with the provisions of Section 25 of the Competition Act, 2010. JVs will be required to seek for exemption from the Competition Authority. Exemption shall not be a condition for tender, but it shall be a condition of contract award and signature. A JV tenderer shall be given opportunity to seek such exemption as a condition of award and signature of contract. Application for exemption from the Competition Authority of Kenya may be accessed from the website www.cak.go.ke.
- 3.13 A Kenyan tenderer shall provide evidence of having fulfilled his/her tax obligations by producing a current tax clearance certificate or tax exemption certificate issued by the Kenya Revenue Authority.

4 Eligible Goods and Related Services

- 4.1 All the Goods and Related Services to be supplied under the Contract shall have their origin in any country that is eligible in accordance with ITT 3.9.
- 4.2 For purposes of this ITT, the term “goods” includes commodities, raw material, machinery, equipment, and industrial plants; and “related services” include services such as insurance, installation, training, and initial maintenance.
- 4.3 The term “origin” means the country where the goods have been mined, grown, cultivated, produced, manufactured or processed; or, through manufacture, processing, or assembly, another commercially recognized article results that differs substantially in its basic characteristics from its components.
- 4.4 A procuring entity shall ensure that the items listed below shall be sourced from Kenya and there shall be no substitutions from foreign sources. The affected items are:
- a) motor vehicles, plant and equipment which are assembled in Kenya;
 - b) furniture, textile, foodstuffs, oil and gas, information communication technology, steel, cement, leather, agro-processed products, sanitary products, and other goods made in Kenya; or
 - c) goods manufactured, mined, extracted or grown in Kenya.
- 4.5 Any goods, works and production processes with characteristics that have been declared by the relevant national environmental protection agency or by other competent authority as harmful to human beings and to the environment shall not be eligible for procurement.

5 Sections of Tendering Document

- 5.1 The tendering document consist of Parts 1, 2, and 3, which include all the sections indicated below, and should be read in conjunction with any Addenda issued in accordance with ITT8.

36 PART 1: Tendering Procedures

- i) Section I - Instructions to Tenderers (ITT)
- ii) Section II - Tendering Data Sheet (TDS)
- iii) Section III - Evaluation and Qualification Criteria
- iv) Section IV - Tendering Forms

37 PART 2: Supply Requirements

- v) Section V - Schedule of Requirements

38 PART 3: Contract

- vi) Section VI - General Conditions of Contract (GCC)
- vii) Section VII - Special Conditions of Contract (SCC)
- viii) Section VIII- Contract Forms

52 The notice of Invitation to Tender or the notice to the prequalified Tenderers issued by the Procuring Entity is not part of the tendering document.

53 Unless obtained directly from the Procuring Entity, the Procuring Entity is not responsible for the completeness of the document, responses to requests for clarification, the minutes of the pre-tender meeting (if any), or addenda to the tendering document in accordance with ITT7.

54 The Tenderer is expected to examine all instructions, forms, terms, and specifications in the tendering document and to furnish with its Tender all information or documentation as is required by the tendering document.

6 Clarification of Tendering Document

61 A Tenderer requiring any clarification of the Tender Document shall contact the Procuring Entity in writing at the Procuring Entity's address specified in the **TDS** or raise its enquiries during the pre-Tender meeting if provided for in accordance with ITT 6.4. The Procuring Entity will respond in writing to any request for clarification, provided that such request is received no later than the period specified in the **TDS** prior to the deadline for submission of tenders. The Procuring Entity shall forward copies of its response to all tenderers who have acquired the Tender documents in accordance with ITT 5.3, including a description of the inquiry but without identifying its source. If so specified in the **TDS**, the Procuring Entity shall also promptly publish its response at the web page identified in the **TDS**. Should the clarification result in changes to the essential elements of the Tender Documents, the Procuring Entity shall amend the Tender Documents following the procedure under ITT 7.

62 The Procuring Entity shall specify in the **TDS** if a pre-tender conference will be held, when and where. The Tenderer's designated representative is invited to attend a pre-Tender meeting. The purpose of the meeting will be to clarify issues and to answer questions on any matter that may be raised at that stage.

63 The Tenderer is requested to submit any questions in writing, to reach the Procuring Entity not later than the period specified in the **TDS** before the meeting.

64 Minutes of the pre-Tender meeting, if applicable, including the text of the questions asked by Tenderers and the responses given, together with any responses prepared after the meeting, will be transmitted promptly to all Tenderers who have acquired the Tender Documents in accordance with ITT 6.3. Minutes shall not identify the source of the questions asked.

65 The Procuring Entity shall also promptly publish anonymized (*no names*) Minutes of the pre-Tender meeting at the web page identified in the **TDS**. Any modification to the Tender Documents that may become necessary as a result of the pre-Tender meeting shall be made by the Procuring Entity exclusively through the issue of an Addendum pursuant to ITT 7 and not through the minutes of the pre-Tender meeting. Nonattendance at the pre-Tender meeting will not be a cause for disqualification of a Tenderer.

7 Amendment of Tendering Document

71 At any time prior to the deadline for submission of Tenders, the Procuring Entity may amend the tendering document by issuing addenda.

72 Any addendum issued shall be part of the tendering document and shall be communicated in writing to all who have obtained the tender document from the Procuring Entity in accordance with ITT 6.3. The Procuring Entity shall also promptly publish the addendum on

the Procuring Entity's web page in accordance with ITT 7.1.

- 73 To give prospective Tenderers reasonable time in which to take an addendum into account in preparing their Tenders, the Procuring Entity may, at its discretion, extend the deadline for the submission of Tenders, pursuant to ITT 21.2.

39 C. Preparation of Tenders

8 Cost of Tendering

- 81 The Tenderer shall bear all costs associated with the preparation and submission of its Tender, and the Procuring Entity shall not be responsible or liable for those costs, regardless of the conduct or outcome of the Tendering process.

9 Language of Tender

- 91 The Tender, as well as all correspondence and documents relating to the Tender exchanged by the Tenderer and the Procuring Entity, shall be written in English Language. Supporting documents and printed literature that are part of the Tender may be in another language provided they are accompanied by an accurate translation of the relevant passages into the English Language, in which case, for purposes of interpretation of the Tender, such translation shall govern.

10 Documents Comprising the Tender

- 101 The Tender shall comprise the following:

- a) Form of Tender prepared in accordance with ITT11;
- b) Price Schedules: completed in accordance with ITT 11 and ITT 13;
- c) Tender Security or Tender-Securing Declaration, in accordance with ITT 18.1;
- d) Alternative Tender: if permissible, in accordance with ITT12;
- e) Authorization: written confirmation authorizing the signatory of the Tender to commit the Tenderer, in accordance with ITT19.3;
- f) Qualifications: documentary evidence in accordance with ITT 16.2 establishing the Tenderer qualifications to perform the Contract if its Tender is accepted;
- g) Tenderer Eligibility: documentary evidence in accordance with ITT16.1 establishing the Tenderer eligibility to tender;
- h) Eligibility of Goods and Related Services: documentary evidence in accordance with ITT 15, establishing the eligibility of the Goods and Related Services to be supplied by the Tenderer;
- i) Conformity: documentary evidence in accordance with ITT15.2 that the Goods and Related Services conform to the tender document; and
- j) any other document required in the **TDS**.

- 102 In addition to the requirements under ITT 10.1, Tenders submitted by a JV shall include a copy of the Joint Venture Agreement entered into by all members. Alternatively, a letter of intent to execute a Joint Venture Agreement in the event of a successful Tender shall be signed by all members and submitted with the Tender, together with a copy of the proposed Agreement.

- 103 The Tenderer shall furnish in the Form of Tender information on commissions gratuities, and fees, if any, paid or to be paid to agents or any other party relating to this Tender.

11 Form of Tender and Price Schedules

- 11.1 The Form of Tender and Price Schedules shall be prepared using the relevant forms furnished in Section IV, Tendering Forms. The forms must be completed without any alterations to the text. All blank spaces shall be filled in with the information requested. The Tenderer shall chronologically serialise pages of all tender documents submitted.

12 Alternative Tenders

121 Unless otherwise specified **in the TDS**, alternative Tenders shall not be considered.

13 Tender Prices and discounts

131 The prices quoted by the Tenderer in the Form of Tender and in the Price, Schedules shall conform to the requirements specified below.

132 All lots (contracts) and items must be listed and priced separately in the Price Schedules.

133 The price to be quoted in the Form of Tender in accordance with ITT10.1 shall be the total price of the Tender, including any discounts offered.

134 The Tenderer shall quote any discounts and indicate the methodology for their application in the form of tender. Conditional discounts will be rejected.

135 Prices quoted by the Tenderer shall be fixed during the performance of the Contract and not subject to variation on any account, unless otherwise specified **in the TDS**. A Tender submitted with an adjustable price quotation shall be treated as non-responsive and shall be rejected, pursuant to ITT 28. However, if in accordance with **the TDS**, prices quoted by the Tenderer shall be subject to adjustment during the performance of the Contract, a Tender submitted with a fixed price quotation shall not be rejected, but the price adjustment shall be treated as zero.

136 If specified in ITT 1.1, Tenders are being invited for individual lots (contracts) or for any combination of lots (packages). Unless otherwise specified **in the TDS**, prices quoted shall correspond to 100 % of the items specified for each lot and to 100% of the quantities specified for each item of a lot. Tenderers wishing to offer discounts for the award of more than one Contract shall specify in their Tender the price reductions applicable to each package, or alternatively, to individual Contracts within the package. Discounts shall be submitted in accordance with ITT 13.4 provided the Tenders for all lots (contracts) are opened at the same time.

137 The terms EXW, CIP, CIF, DDP and other similar terms shall be governed by the rules prescribed in the current edition of Incoterms, published by the International Chamber of Commerce.

138 Prices shall be quoted as specified in each Price Schedule included in Section IV, Tendering Forms. The disaggregation of price components is required solely for the purpose of facilitating the comparison of Tenders by the Procuring Entity. This shall not in any way limit the Procuring Entity's right to contract on any of the terms offered. In quoting prices, the Tenderer shall be free to use transportation through carriers registered in any eligible country. Similarly, the Tenderer may obtain insurance services from any eligible country in accordance with ITT 3.6, Eligible Tenders. Prices shall be entered in the following manner:

- a) For Goods manufactured in Kenya:
 - i) the price of the Goods quoted EXW (ex-works, ex-factory, ex warehouse, ex showroom, or off-the- shelf, as applicable) final destination point indicated in the **TDS**, including all customs duties and sales and other taxes already paid or payable on the components and raw material used in the manufacture or assembly of the Goods;
 - ii) any sales tax and other taxes which will be payable in Kenya on the Goods if the Contract is awarded to the Tenderer; and
 - iii) the price for inland transportation, insurance, and other local services required to convey the Goods to their final destination specified **in the TDS**.
- b) For Goods manufactured outside Kenya, to be imported:
 - i) the price of the Goods, quoted CIP named place of destination, in Kenya, as specified **in the TDS**;
 - ii) the price for inland transportation, insurance, and other local services required to convey the

Goods from the named place of destination to their final destination specified **in the TDS**;

- c) For Goods manufactured outside Kenya, already imported:
 - i) the price of the Goods, including the original import value of the Goods; plus, any mark-up (or rebate); plus, any other related local cost, and custom duties and other import taxes already paid or to be paid on the Goods already imported;
 - ii) the custom duties and other import taxes already paid (need to be supported with documentary evidence) or to be paid on the Goods already imported;
 - iii) any sales and other taxes levied in Kenya which will be payable on the Goods if the Contract is awarded to the Tenderer; and
 - iv) the price for inland transportation, insurance, and other local services required to convey the Goods from the named place of destination to their final destination (Project Site) specified **in the TDS**.
- d) for Related Services, other than inland transportation and other services required to convey the Goods to their final destination, whenever such Related Services are specified in the Schedule of Requirements, the price of each item comprising the Related Services (inclusive of any applicable taxes).

14 Currencies of Tender and Payment

141 The currency (ies) of the Tender, the currency (ies) of award and the currency (ies) of contract payments shall be the same.

142 The Tenderer shall quote in Kenya shillings. If allowed in the **TDS**, the Tenderer may express the Tender price in any currency, provided it shall use no more than two foreign currencies in addition to the Kenya Shilling.

143 The rates of exchange to be used by the Tenderer shall be based on the exchange rates provided by the Central Bank of Kenya on the date 30 days prior to the actual date of tender opening.

15 Documents Establishing the Eligibility and Conformity of the Goods and Related Services

151 To establish the eligibility of the Goods and Related Services in accordance with ITT 15, Tenderers shall complete the country of origin declarations in the Price Schedule Forms, included in Section IV, Tendering Forms.

152 To establish the conformity of the Goods and Related Services to the tendering document, the Tenderer shall furnish as part of its Tender the documentary evidence that the Goods conform to the technical specifications and standards specified in Section VII, Schedule of Requirements.

153 The documentary evidence may be in the form of literature, drawings or data, and shall consist of a detailed item by item description of the essential technical and performance characteristics of the Goods and Related Services, demonstrating substantial responsiveness of the Goods and Related Services to the technical specification, and if applicable, a statement of deviations and exceptions to the provisions of the Section VII, Schedule of Requirements.

154 The Tenderer shall also furnish a list giving full particulars, including available sources and current prices of spare parts, special tools, etc., necessary for the proper and continuing functioning of the Goods during the period **specified in the TDS** following commencement of the use of the goods by the Procuring Entity.

155 Standards for workmanship, process, material, and equipment, as well as references to brand names or catalogue numbers specified by the Procuring Entity in the Schedule of Requirements, are intended to be descriptive only and not restrictive. The Tenderer may offer other standards of quality, brand names, and/or catalogue numbers, provided that it demonstrates, to the Procuring Entity's satisfaction, that the substitutions ensure substantial equivalence or are superior to those specified in the Section VII, Schedule of Requirements.

16 Documents Establishing the Eligibility and Qualifications of the Tenderer

161 To establish Tenderer eligibility in accordance with ITT 4, Tenderers shall complete the Form of Tender, included in Section IV, Tendering Forms.

162 The documentary evidence of the Tenderer qualifications to perform the Contract if its Tender is accepted shall establish to the Procuring Entity's satisfaction:

- a) that, if required **in the TDS**, a Tenderer that does not manufacture or produce the Goods it offers to supply shall submit the Manufacturer's Authorization using the form included in Section IV, Tendering Forms to demonstrate that it has been duly authorized by the manufacturer or producer of the Goods to supply these Goods in Kenya;

- b) that, if required **in the TDS**, in case of a Tenderer not doing business within the Kenya, the Tenderer is or will be (if awarded the Contract) represented by an Agent in the country equipped and able to carry out the Supplier's maintenance, repair and spare parts-stocking obligations prescribed in the Conditions of Contract and/or Technical Specifications; and
- c) that the Tenderer meets each of the qualification criterion specified in Section III, Evaluation and Qualification Criteria.

17. Period of Validity of Tenders

- 171 Tenders shall remain valid for the Tender Validity period specified **in the TDS**. The Tender Validity period starts from the date fixed for the Tender submission deadline (as prescribed by the Procuring Entity in accordance with ITT 21.1). A Tender valid for a shorter period shall be rejected by the Procuring Entity as non-responsive.
- 172 In exceptional circumstances, prior to the expiration of the Tender validity period, the Procuring Entity may request Tenderers to extend the period of validity of their Tenders. The request and the responses shall be made in writing. If a Tender Security is requested in accordance with ITT 18, it shall also be extended for a corresponding period. A Tenderer may refuse the request without forfeiting its Tender Security. A Tenderer granting the request shall not be required or permitted to modify its Tender, except as provided in ITT 17.3.
- 173 If the award is delayed by a period exceeding the number of days to be specified in the **TDS** days beyond the expiry of the initial tender validity period, the Contract price shall be determined as follows:
- a) in the case of **fixed price** contracts, the Contract price shall be the tender price adjusted by the factor specified **in the TDS**;
 - b) in the case of **adjustable price** contracts, no adjustment shall be made; or in any case, tender evaluation shall be based on the tender price without taking into consideration the applicable correction from those indicated above.

18. Tender Security

- 181 The Tenderer shall furnish as part of its Tender, either a Tender-Securing Declaration or a Tender Security, as specified **in the TDS**, in original form and, in the case of a Tender Security, in the amount and currency specified **in the TDS**.
- 182 A Tender Securing Declaration shall use the form included in Section IV, Tendering Forms.
- 183 If a Tender Security is specified pursuant to ITT 18.1, the Tender Security shall be a demand guarantee in any of the following forms at the Tenderer option:
- i) cash;
 - ii) a bank guarantee;
 - iii) a guarantee by an insurance company registered and licensed by the Insurance Regulatory Authority listed by the Authority; or
 - iv) a letter of credit; or
 - v) guarantee by a deposit taking micro-finance institution, Sacco society, the Women Enterprise Development Fund or the Women Enterprise Fund.
- 184 If an unconditional guarantee is issued by a non-Bank financial institution located outside Kenya, the issuing non-Bank financial institution shall have a correspondent financial institution located in Kenya to make it enforceable unless the Procuring Entity has agreed in writing, prior to Tender submission, that a correspondent financial institution is not required. In the case of a bank guarantee, the Tender Security shall be submitted either using the Tender Security Form included in Section IV, Tendering Forms, or in another substantially similar format approved by the Procuring Entity prior to Tender submission. The Tender Security shall be valid for thirty (30) days beyond the original validity period of the Tender, or beyond any period of extension if requested under ITT 17.2.
- 185 If a Tender Security is specified pursuant to ITT 18.1, any Tender not accompanied by a substantially responsive Tender Security shall be rejected by the Procuring Entity as non-

responsive.

- 186 If a Tender Security is specified pursuant to ITT 18.1, the Tender Security of unsuccessful Tenderers shall be returned as promptly as possible upon the successful Tenderer signing the Contract and furnishing the Performance Security pursuant to ITT 46. The Procuring Entity shall also promptly return the tender security to the tenderers where the procurement proceedings are terminated, all tenders were determined non-responsive or a bidder declines to extend tender validity period.
- 187 The Tender Security of the successful Tenderer shall be returned as promptly as possible once the successful Tenderer has signed the Contract and furnished the required Performance Security.
- 188 The Tender Security may be forfeited or the Tender Securing Declaration executed:
- a) if a Tenderer withdraws its Tender during the period of Tender validity specified by the Tenderer in the Form of Tender, or any extension thereto provided by the Tenderer; or
 - b) if the successful Tenderer fails to:
 - i) sign the Contract in accordance with ITT 45; or
 - ii) furnish a Performance Security in accordance with ITT 46.
- 189 Where tender securing declaration is executed, the Procuring Entity shall recommend to the PPRA that PPRA debars the Tenderer from participating in public procurement as provided in the law.
- 1810 The Tender Security or Tender- Securing Declaration of a JV must be in the name of the JV that submits the Tender. If the JV has not been legally constituted into a legally enforceable JV at the time of Tendering, the Tender Security or Tender-Securing Declaration shall be in the names of all future members as named in the letter of intent referred to in ITT3.1 and ITT 10.2.
- 1811 A tenderer shall not issue a tender security to guarantee itself.

19. Format and Signing of Tender

- 191 The Tenderer shall prepare one original of the documents comprising the Tender as described in ITT 11 and clearly mark it "ORIGINAL." Alternative Tenders, if permitted in accordance with ITT 12, shall be clearly marked "ALTERNATIVE." In addition, the Tenderer shall submit copies of the Tender, in the number **specified in the TDS** and clearly mark them "COPY." In the event of any discrepancy between the original and the copies, the original shall prevail.
- 192 Tenderers shall mark as "CONFIDENTIAL" information in their Tenders which is confidential to their business. This may include proprietary information, trade secrets, or commercial or financially sensitive information.
- 193 The original and all copies of the Tender shall be typed or written in indelible ink and shall be signed by a person duly authorized to sign on behalf of the Tenderer. This authorization shall consist of a written confirmation **as specified in the TDS** and shall be attached to the Tender. The name and position held by each person signing the authorization must be typed or printed below the signature. All pages of the Tender where entries or amendments have been made shall be signed or initialed by the person signing the Tender.
- 194 In case the Tenderer is a JV, the Tender shall be signed by an authorized representative of the JV on behalf of the JV, and so as to be legally binding on all the members as evidenced by a power of attorney signed by each members' legally authorized representatives.
- 195 Any inter-lineation, erasures, or overwriting shall be valid only if they are signed or initialed by the person signing the Tender.

40 D. Submission and Opening of Tenders

20 Sealing and Marking of Tenders

- 201 Depending on the sizes or quantities or weight of the tender documents, a tenderer may use an envelope, package or container. The Tenderer shall deliver the Tender in a single sealed envelope, or in a single sealed package, or in a single sealed container bearing the name and Reference number of the Tender, addressed to the Procuring Entity and a warning not

- to open before the time and date for Tender opening date. Within the single envelope, package or container, the Tenderer shall place the following separate, sealed envelopes:
- a) in an envelope or package or container marked “ORIGINAL”, all documents comprising the Tender, as described in ITT 11; and
 - b) in an envelope or package or container marked “COPIES”, all required copies of the Tender; and
 - c) if alternative Tenders are permitted in accordance with ITT 12, and if relevant:
 - i) in an envelope or package or container marked “ORIGINAL –ALTERNATIVE TENDER”, the alternative Tender; and
 - ii) in the envelope or package or container marked “COPIES- ALTERNATIVE TENDER”, all required copies of the alternative Tender.
- 202 The inner envelopes or packages or containers shall:
- a) bear the name and address of the Procuring Entity.
 - b) bear the name and address of the Tenderer; and
 - c) bear the name and Reference number of the Tender.
- 203 Where a tender package or container cannot fit in the tender box, the procuring entity shall:
- a) Specify in the **TDS where** such documents should be received.
 - b) maintain a record of tenders received and issue acknowledgement receipt note to each tenderer specifying time and date of receipt.
 - c) Ensure all tenders received are handed over to the tender opening committee for opening at the specified opening place and time.
- 204 If an envelope or package or container is not sealed and marked as required, the *Procuring Entity* will assume no responsibility for the misplacement or premature opening of the Tender. Tenders misplaced or opened prematurely will not be accepted.

21. Deadline for Submission of Tenders

- 21.1 Tenders must be received by the Procuring Entity at the address and no later than the date and time specified **in the TDS**. When so specified **in the TDS**, Tenderers shall have the option of submitting their Tenders electronically. Tenderers submitting Tenders electronically shall follow the electronic Tender submission procedures **specified in the TDS**.
- 21.2 The Procuring Entity may, at its discretion, extend the deadline for the submission of Tenders by amending the tendering document in accordance with ITT7, in which case all rights and obligations of the Procuring Entity and Tenderers previously subject to the deadline shall thereafter be subject to the deadline as extended.

22. Late Tenders

- 22.1 The Procuring Entity shall not consider any Tender that arrives after the deadline for submission of Tenders. Any Tender received by the Procuring Entity after the deadline for submission of Tenders shall be declared late, rejected, and returned unopened to the Tenderer.

23. Withdrawal, Substitution, and Modification of Tenders

- 23.1 A Tenderer may withdraw, substitute, or modify its Tender after it has been submitted by sending a written notice, duly signed by an authorized representative, and shall include a copy of the authorization (the power of attorney) in accordance with ITT19.3, (except that withdrawal notices do not require copies). The corresponding substitution or modification of the Tender must accompany the respective written notice. All notices must be:
- a) prepared and submitted in accordance with ITT 20 and 21 (except that withdrawal notices do not require copies), and in addition, the respective envelopes shall be clearly marked “WITHDRAWAL,” “SUBSTITUTION,” or “MODIFICATION;” and
 - b) received by the Procuring Entity prior to the deadline prescribed for submission of Tenders, in accordance with ITT 22.
- 23.3 Tenders requested to be withdrawn in accordance with ITT 23.1 shall be returned

unopened to the Tenderers.

234 No Tender may be withdrawn, substituted, or modified in the interval between the deadline for submission of Tenders and the expiration of the period of Tender validity specified by the Tenderer on the Form of Tender or any extension thereof.

24 Tender Opening

241 Except as in the cases specified in ITT 23, the Procuring Entity shall, at the Tender opening, publicly open and read out all Tenders received by the deadline at the date, time and place specified **in the TDS** in the presence of Tenderers' designated representatives who choose to attend, including to attend any specific electronic tender opening procedures if electronic tendering is permitted in accordance with ITT 21.1, shall be as specified **in the TDS**.

242 First, envelopes marked "WITHDRAWAL" shall be opened and read out and the envelope with the corresponding Tender shall not be opened, but returned to the Tenderer. If the withdrawal envelope does not contain a copy of the "power of attorney" confirming the signature as a person duly authorized to sign on behalf of the Tenderer, the corresponding Tender will be opened. No Tender withdrawal shall be permitted unless the corresponding withdrawal notice contains a valid authorization to request the withdrawal and is read out at Tender opening.

243 Next, envelopes marked "SUBSTITUTION" shall be opened and read out and exchanged with the corresponding Tender being substituted, and the substituted Tender shall not be opened, but returned to the Tenderer. No Tender substitution shall be permitted unless the corresponding substitution notice contains a valid authorization to request the substitution and is read out at Tender opening.

244 Next, envelopes marked "MODIFICATION" shall be opened and read out with the corresponding Tender. No Tender modification shall be permitted unless the corresponding modification notice contains a valid authorization to request the modification and is read out at Tender opening.

245 Next, all remaining envelopes shall be opened one at a time, reading out: the name of the Tenderer and whether there is a modification; the total Tender Prices, per lot (contract) if applicable, including any discounts and alternative Tenders; the presence or absence of a Tender Security, if required; and any other details as the Procuring Entity may consider appropriate.

246 Only Tenders, alternative Tenders and discounts that are opened and read out at Tender opening shall be considered further for evaluation. The Form of Tender and pages of the Bills of Quantities are to be initialed by the members of the tender opening committee attending the opening. The number of representatives of the Procuring Entity to sign shall be specified in the **TDS**.

247 The Procuring Entity shall neither discuss the merits of any Tender nor reject any Tender (except for late Tenders, in accordance with ITT 22.1).

248 The Procuring Entity shall prepare a record of the Tender opening that shall include, as a minimum:

- a) the name of the Tenderer and whether there is a withdrawal, substitution, or modification;
- b) the Tender Price, per lot (contract) if applicable, including any discounts;
- c) any alternative Tenders;
- d) the presence or absence of a Tender Security or Tender-Securing Declaration, if one was required;
- e) number of pages of each tender document submitted.

249 The Tenderers' representatives who are present shall be requested to sign the record. The omission of a Tenderer signature on the record shall not invalidate the contents and effect of the record. A copy of the tender opening register shall be issued to a Tenderer upon request.

41 E. Evaluation and Comparison of Tenders

25. Confidentiality

- 25.1 Information relating to the evaluation of Tenders and recommendation of contract award, shall not be disclosed to Tenderers or any other persons not officially concerned with the tendering process until the information on Intention to Award the Contract is transmitted to all Tenderers in accordance with ITT 41.
- 25.2 Any effort by a Tenderer to influence the Procuring Entity in the evaluation or contract award decisions may result in the rejection of its Tender.
- 25.3 Notwithstanding ITT 25.2, from the time of Tender opening to the time of Contract Award, if any Tenderer wishes to contact the Procuring Entity on any matter related to the Tendering process, it should do so in writing.

26. Clarification of Tenders

- 26.1 To assist in the examination, evaluation, comparison of the Tenders, and qualification of the Tenderers, the Procuring Entity may, at its discretion, ask any Tenderer for a clarification of its Tender. Any clarification submitted by a Tenderer in respect to its Tender and that is not in response to a request by the Procuring Entity shall not be considered. The Procuring Entity's request for clarification and the response shall be in writing. No change, including any voluntary increase or decrease, in the prices or substance of the Tender shall be sought, offered, or permitted except to confirm the correction of arithmetic errors discovered by the Procuring Entity in the Evaluation of the Tenders, in accordance with ITT 30.

If a Tenderer does not provide clarifications of its Tender by the date and time set in the Procuring Entity's request for clarification, its Tender may be rejected.

27. Deviations, Reservations, and Omissions

- 27.1 During the evaluation of Tenders, the following definitions apply:
- a) "Deviation" is a departure from the requirements specified in the Tendering document;
 - b) "Reservation" is the setting of limiting conditions or withholding from complete acceptance of the requirements specified in the tendering document; and
 - c) "Omission" is the failure to submit part or all of the information or documentation required in the tendering document.

28. Determination of Responsiveness

- 28.1 The Procuring Entity's determination of a Tender's responsiveness is to be based on the contents of the Tender itself, as defined in ITT28.2.
28. A substantially responsive Tender is one that meets the requirements of the tendering document without material deviation, reservation, or omission. A material deviation, reservation, or omission is one that:
- a) if accepted, would:
 - i) affect in any substantial way the scope, quality, or performance of the Goods and Related Services specified in the Contract; or
 - ii) limit in any substantial way, inconsistent with the tendering document, the Procuring Entity's rights or the Tenderer obligations under the Contract; or
 - b) if rectified, would unfairly affect the competitive position of other Tenderers presenting substantially responsive Tenders.
- 28.2 The Procuring Entity shall examine the technical aspects of the Tender submitted in accordance with ITT 15 and ITT 16, in particular, to confirm that all requirements of Section VII, Schedule of Requirements have been met without any material deviation or reservation, or omission.

283 If a Tender is not substantially responsive to the requirements of tendering document, it shall be rejected by the Procuring Entity and may not subsequently be made responsive by correction of the material deviation, reservation, or omission.

29. Non-conformities, Errors and Omissions

291 Provided that a Tender is substantially responsive, the Procuring Entity may waive any non-conformities in the Tender.

292 Provided that a Tender is substantially responsive, the Procuring Entity may request that the Tenderer submit the necessary information or documentation, within a reasonable period of time, to rectify nonmaterial non- conformities or omissions in the Tender related to documentation requirements. Such omission shall not be related to any aspect of the price of the Tender. Failure of the Tenderer to comply with the request may result in the rejection of its Tender.

293 Provided that a Tender is substantially responsive, the Procuring Entity shall rectify quantifiable nonmaterial non-conformities related to the Tender Price. To this effect, the Tender Price shall be adjusted, for comparison purposes only, to reflect the price of a missing or non-conforming item or component in the manner specified **in the TDS**. The adjustment shall be based on the *average* price of the item or component as quoted in other substantially responsive Tenders. If the price of the item or component cannot be derived from the price of other substantially responsive Tenders, the Procuring Entity shall use its best estimate.

30. Arithmetical Errors

301 The tender sum as submitted and read out during the tender opening shall be absolute and final and shall not be the subject of correction, adjustment or amendment in any way by any person or entity.

302 Provided that the Tender is substantially responsive, the Procuring Entity shall handle errors on the following basis:

- a) Any error detected if considered a major deviation that affects the substance of the tender, shall lead to disqualification of the tender as non-responsive .
- b) Any errors in the submitted tender arising from a miscalculation of unit price, quantity, subtotal and total bid price shall be considered as a major deviation that affects the substance of the tender and shall lead to disqualification of the tender as non-responsive. and
- c) if there is a discrepancy between words and figures, the amount in words shall prevail.

303 Tenderers shall be notified of any error detected in their bid during the notification of a ward.

31. Conversion to Single Currency

311 For evaluation and comparison purposes, the currency(ies) of the Tender shall be converted in a single currency as specified **in the TDS**.

32. Margin of Preference and Reservations

321 A margin of preference may be allowed on locally manufactured goods only when the contract is open to international tendering, where the tender is likely to attract foreign goods and where the contract exceeds the threshold specified in the Regulations.

322 For purposes of granting a margin of preference on locally manufactured goods under international competitive tendering, a procuring entity shall not subject the items listed below to international tender and hence no margin of preference shall be allowed. The affected items are:

- a) motor vehicles, plant and equipment which are assembled in Kenya;
- b) furniture, textile, foodstuffs, oil and gas, information communication technology, steel, cement, leather agro-processing, sanitary products, and other goods made in Kenya; or

- c) goods manufactured, mined, extracted or grown in Kenya.
- 323 A margin of preference shall not be allowed unless it is specified so in the **TDS**.
- 324 Contracts procured on basis of international competitive tendering shall not be subject to reservations to specific groups as provided in ITT 32.5.
- 325 Where it is intended to reserve a contract to a specific group of businesses (these groups are Small and Medium Enterprises, Women Enterprises, Women Enterprises and Enterprises of persons living with disability, as the case may be), and who are appropriately registered as such by the authority to be specified in the **TDS**, a procuring entity shall ensure that the invitation to tender specifically indicates that only businesses or firms belonging to the specified group are eligible to tender as specified in the **TDS**. No tender shall be reserved to more than one group. If not so stated in the Tender documents, the invitation to tender will be open to all interested tenderers.
- 33. Evaluation of Tenders**
- 331 The Procuring Entity shall use the criteria and methodologies listed in this ITT and Section III, Evaluation and Qualification criteria. No other evaluation criteria or methodologies shall be permitted. By applying the criteria and methodologies, the Procuring Entity shall determine the Lowest Evaluated Tender. This is the Tender of the Tenderer that meets the qualification criteria and whose Tender has been determined to be:
- a) substantially responsive to the tender documents; and
 - b) the lowest evaluated price.
- 332 Price evaluation will be done for Items or Lots (contracts), as specified **in the TDS**; and the Tender Price as quoted in accordance with ITT 14. To evaluate a Tender, the Procuring Entity shall consider the following:
- a) price adjustment due to unconditional discounts offered in accordance with ITT 13.4;
 - b) converting the amount resulting from applying (a) and (b) above, if relevant, to a single currency in accordance with ITT 31;
 - c) price adjustment due to quantifiable nonmaterial non-conformities in accordance with ITT 29.3; and
 - d) any additional evaluation factors specified **in the TDS** and Section III, Evaluation and Qualification Criteria.
- 333 The estimated effect of the price adjustment provisions of the Conditions of Contract, applied over the period of execution of the Contract, shall not be considered in Tender evaluation.
- 334 Where the tender involves multiple lots or contracts, the tenderer will be allowed to tender for one or more lots (contracts). Each lot or contract will be evaluated in accordance with ITT 33.2. The methodology to determine the lowest evaluated tenderer or tenderers based one lot (contract) or based on a combination of lots (contracts), will be specified in Section III, Evaluation and Qualification Criteria. In the case of multiple lots or contracts, tenderer will be will be required to prepare the Eligibility and Qualification Criteria Form for each Lot.
- 335 The Procuring Entity's evaluation of a Tender will include and consider:
- a) in the case of Goods manufactured in Kenya, sales and other similar taxes, which will be payable on the goods if a contract is awarded to the Tenderer;
 - b) in the case of Goods manufactured outside Kenya, already imported or to be imported, customs duties and other import taxes levied on the imported Good, sales and other similar taxes, which will be payable on the Goods if the contract is awarded to the Tenderer;
- 336 The Procuring Entity's evaluation of a Tender may require the consideration of other factors, in addition to the Tender Price quoted in accordance with ITT 14. These factors may be related to the characteristics, performance, and terms and conditions of purchase of the Goods and Related Services. The effect of the factors selected, if any, shall be expressed in monetary terms to facilitate comparison of Tenders, unless otherwise specified in the **TDS** from amongst those set out in Section III, Evaluation and Qualification Criteria. The additional criteria and methodologies to be used shall be as specified in ITT 33.2(d).

34. Comparison of Tenders

34.1 The Procuring Entity shall compare the evaluated costs of all substantially responsive Tenders established in accordance with ITT 33.2 to determine the Tender that has the lowest evaluated cost. The comparison shall be on the basis of total cost (place of final destination) prices for all goods and all prices, plus cost of inland transportation and insurance to place of destination, for goods manufactured within the Kenya, together with prices for any required installation, training, commissioning and other services.

35. Abnormally Low Tenders

35.1 An Abnormally Low Tender is one where the Tender price, in combination with other constituent elements of the Tender, appears unreasonably low to the extent that the Tender price raises material concerns with the Procuring Entity as to the capability of the Tenderer to perform the Contract for the offered Tender price.

35.2 In the event of identification of a potentially Abnormally Low Tender by the evaluation committee, the Procuring Entity shall seek written clarification from the Tenderer, including a detailed price analyses of its Tender price in relation to the subject matter of the contract, scope, delivery schedule, allocation of risks and responsibilities and any other requirements of the tendering document.

35.3 After evaluation of the price analysis, in the event that the Procuring Entity determines that the Tenderer has failed to demonstrate its capability to perform the contract for the offered Tender price, the Procuring Entity shall reject the Tender.

36. Abnormally High Tenders

41.4 An abnormally high price is one where the tender price, in combination with other constituent elements of the Tender, appears unreasonably too high to the extent that the Procuring Entity is concerned that it (the Procuring Entity) may not be getting value for money or it may be paying too high a price for the contract compared with market prices or that genuine competition between Tenderers is compromised.

41.5 In case of an abnormally high tender price, the Procuring Entity shall make a survey of the market prices, check if the estimated cost of the contract is correct and review the Tender Documents to check if the specifications, scope of work and conditions of contract are contributory to the abnormally high tenders. The Procuring Entity may also seek written clarification from the tenderer on the reason for the high tender price. The Procuring Entity shall proceed as follows:

- i) If the tender price is abnormally high based on wrong estimated cost of the contract, the Procuring Entity may accept or not accept the tender depending on the Procuring Entity's budget considerations.
- ii) If specifications, scope of work and/or conditions of contract are contributory to the abnormally high tender prices, the Procuring Entity shall reject all tenders and may retender for the contract based on revised estimates, specifications, scope of work and conditions of contract, as the case may be.

41.6 If the Procuring Entity determines that the Tender Price is abnormally too high because genuine competition between tenderers is compromised (*often due to collusion, corruption or other manipulations*), the Procuring Entity shall reject all Tenders and shall institute or cause relevant Government Agencies to institute an investigation on the cause of the compromise, before retendering.

37. Post-Qualification of the Tenderer

37.1 The Procuring Entity shall determine, to its satisfaction, whether the eligible Tenderer that is selected as having submitted the lowest evaluated cost and substantially responsive Tender, meets the qualifying criteria specified in Section III, Evaluation and Qualification Criteria.

37.2 The determination shall be based upon an examination of the documentary evidence of the Tenderer qualifications submitted by the Tenderer, pursuant to ITT 15 and 16. The

determination shall not take into consideration the qualifications of other firms such as the Tenderer subsidiaries, parent entities, affiliates, subcontractors (other than specialized subcontractors if permitted in the tendering document), or any other firm(s) different from the Tenderer.

373 An affirmative determination shall be a prerequisite for award of the Contract to the Tenderer. A negative determination shall result in disqualification of the Tender, in which event the Procuring Entity shall proceed to the Tenderer who offers a substantially responsive Tender with the next lowest evaluated cost to make a similar determination of that Tenderer qualifications to perform satisfactorily.

38. Lowest Evaluated Tender

38.1 Having compared the evaluated prices of Tenders, the Procuring Entity shall determine the Lowest Evaluated Tender. The Lowest Evaluated Tender is the Tender of the Tenderer that meets the Qualification Criteria and whose Tender has been determined to be:

- a) most responsive to the Tender document; and
- b) the lowest evaluated price.

39. Procuring Entity's Right to Accept Any Tender, and to Reject Any or All Tenders.

39.1 The Procuring Entity reserves the right to accept or reject any Tender, and to annul the Tendering process and reject all Tenders at any time prior to notification Award, without thereby incurring any liability to Tenderers. In case of annulment, all Tenderers shall be notified with reasons and all Tenders submitted and specifically, tender securities, shall be promptly returned to the Tenderers.

42 F. Award of Contract

40. Award Criteria

40.1 The Procuring Entity shall award the Contract to the successful tenderer whose tender has been determined to be the Lowest Evaluated Tender in accordance with procedures in Section 3: Evaluation and Qualification Criteria.

41. Procuring Entity's Right to Vary Quantities at Time of Award

41.1 The Procuring Entity reserves the right at the time of Contract award to increase or decrease, by the percentage (s) for items as indicated in the TDS.

42. Notice of Intention to enter into a Contract

Upon award of the contract and Prior to the expiry of the Tender Validity Period the Procuring Entity shall issue a Notification of Intention to Enter into a Contract / Notification of award to all tenderers which shall contain, at a minimum, the following information:

- a) the name and address of the Tenderer submitting the successful tender;
- b) the Contract price of the successful tender;
- c) a statement of the reason(s) the tender of the unsuccessful tenderer to whom the letter is addressed was unsuccessful, unless the price information in (c) above already reveals the reason;
- d) the expiry date of the Standstill Period; and
- e) instructions on how to request a debriefing and/or submit a complaint during the standstill period;

43. Standstill Period

43.1 The Contract shall not be awarded earlier than the expiry of a Standstill Period of 14 days to allow any dissatisfied candidate to launch a complaint. Where only one Tender is submitted, the Standstill Period shall not apply.

432 Where standstill period applies, it shall commence when the Procuring Entity has transmitted to each Tenderer the Notification of Intention to Enter into a Contract to the successful Tenderer.

44. Debriefing by the Procuring Entity

441 On receipt of the Procuring Entity's Notification of Intention to Enter into a Contract referred to in ITT 41, an unsuccessful tenderer may make a written request to the Procuring Entity for a debriefing on specific issues or concerns regarding their tender. The Procuring Entity shall provide the debriefing within five days of receipt of the request.

442 Debriefings of unsuccessful Tenderers may be done in writing or verbally. The Tenderer shall bear its own costs of attending such a debriefing meeting.

45. Letter of Award

Prior to the expiry of the Tender Validity Period and upon expiry of the Standstill Period specified in ITT 42, upon addressing a complaint that has been filed within the Standstill Period, the Procuring Entity shall transmit the Letter of Award to the successful Tenderer. The letter of award shall request the successful tenderer to furnish the Performance Security within 21days of the date of the letter.

46. Signing of Contract

43

461 Upon the expiry of the fourteen days of the Notification of Intention to enter into contract and upon the parties meeting their respective statutory requirements, the Procuring Entity shall send the successful Tenderer the Contract Agreement.

462 Within fourteen (14) days of receipt of the Contract Agreement, the successful Tenderer shall sign, date, and return it to the Procuring Entity.

463 The written contract shall be entered into within the period specified in the notification of award and before expiry of the tender validity period.

47. Performance Security

44

471 Within twenty-one (21) days of the receipt of Letter of Acceptance from the Procuring Entity, the successful Tenderer, if required, shall furnish the Performance Security in accordance with the GCC 18, using for that purpose the Performance Security Form included in Section X, Contract Forms. If the Performance Security furnished by the successful Tenderer is in the form of a bond, it shall be issued by a bonding or insurance company that has been determined by the successful Tenderer to be acceptable to the Procuring Entity. A foreign institution providing a bond shall have a correspondent financial institution located in Kenya, unless the Procuring Entity has agreed in writing that a correspondent financial institution is not required.

472 Failure of the successful Tenderer to submit the above-mentioned Performance Security or sign the Contract shall constitute sufficient grounds for the annulment of the award and forfeiture of the Tender Security. In that event the Procuring Entity may award the Contract to the Tenderer offering the next lowest Evaluated Tender.

473 Performance security shall not be required for a contract, if so specified in the **TDS**.

48. Publication of Procurement Contract

481 Within fourteen days after signing the contract, the Procuring Entity shall publish and publicize the awarded contract at its notice boards, entity website; and on the Website of the Authority in manner and format prescribed by the Authority. At the minimum, the notice shall contain the following information:

- a) name and address of the Procuring Entity;
- b) name and reference number of the contract being awarded, a summary of its scope and the selection method used;
- c) the name of the successful Tenderer, the final total contract price, the contract duration.
- d) dates of signature, commencement and completion of contract;
- e) names of all Tenderers that submitted Tenders, and their Tender prices as read out at Tender opening;



49. Procurement Related Complaints and Administrative Review





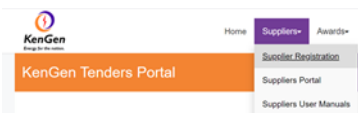

49.1 The procedures for making a Procurement-related Complaint are as specified in the TDS.

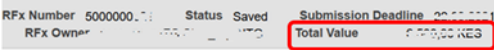

49.2 A request for administrative review shall be made in the form provided under contract forms.

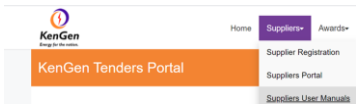



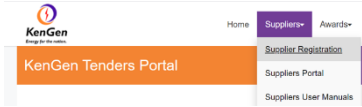

SECTION II – TENDER DATA SHEET (TDS)

The following specific data shall complement, supplement, or amend the provisions in the Instructions to Tenderers (ITT). Whenever there is a conflict, the provisions herein shall prevail over those in ITT.

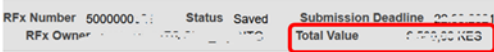
ITT Reference	Particulars Of Appendix To Instructions To Tenders
A. General	
ITT 1.1	<p>The reference number of the Invitation for Tenders is: KGN-KIP-015-2024</p> <p>The Procuring Entity is <i>Kenya Electricity Generating Company PLC</i></p> <p>The name of the Contract is: TENDER FOR SUPPLY OF HYDRAULIC EQUIPMENT FOR KIPEVU III POWER PLANT.</p>
ITT 1.2(a)	<p>Electronic –Procurement System</p> <p>1.For suppliers registering for the first time using the link https://supplierregistration.kengen.co.ke:4302/slc_selfreg(bD1lbiZjPTMwMCZkPW1pbg==)/bspwdapplication.do#VIEW_ANCHOR-ROS_TOP ensure the “Public Tender” checkbox is ticked so that the login details are sent to suppliers automatically</p>  <p>It is a mandatory requirement all Documents MUST be uploaded to the SRM System through the link https://eprocurement.kengen.co.ke:50001/irj/portal found on www.kengen.co.ke.</p>  <p>After clicking on the Event Number, then click on Register (for Open tenders), then click on ‘Create Response’, bidders to click on ‘Technical RFx Response’ tab to access the cfolder page to upload your document.</p> <p><u>Instructions to Bidders: Caution on Uploading Bid Documents</u></p> <ol style="list-style-type: none"> a. Preferred Submission Method: Bidders are advised to use the C-Folder for submitting their tenders. This platform is specifically designed to handle bulky technical bid documents of up to 99MB per file. b. Exceeding File Size Limit: In the event that the bid response exceeds the 99MB limit: - <ol style="list-style-type: none"> i. Bidders should try to compress the pdf file first to file size less than 99MB and if compressing doesn’t reduce the file size consider option (ii) below. ii. Split the documents into two or more separate files before submission. This ensures the integrity of the tendering process and accurate evaluation of all necessary information. c. Bids uploaded on Notes and Attachments" Tab may have a transmission failure and the bid may not be successfully received through the system and KenGen will not be held accountable for failure to transmit on eProcurement portal

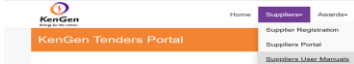
ITT Reference	Particulars Of Appendix To Instructions To Tenders																								
ITT 1.2(a)	<p>d. Assistance and Inquiries: For any questions or further assistance, bidders are encouraged to reach out to the team at least 24 hours before submission deadline through eprocurement@kengen.co.ke; or tenders@kengen.co.ke; or visit our offices through the Karibu Centre.</p> <ul style="list-style-type: none"> Prices MUST be entered under item tab of the RfX and MUST be similar to the prices in the price Schedule.  <ul style="list-style-type: none"> Bidders should confirm on the supplier portal that the status of their RfX response shows “Submitted” and not “Saved” to ensure their RfX <table border="1" data-bbox="432 595 1434 696"> <thead> <tr> <th>Event Number</th> <th>Event Description</th> <th>Event Type</th> <th>Event Status</th> <th>Start Date</th> <th>End Date</th> <th>Response Number</th> <th>Response Status</th> </tr> </thead> <tbody> <tr> <td>5000000000</td> <td>Test Bid Invite Notification to Bidders</td> <td>Open Tendering</td> <td>Published</td> <td></td> <td>22.09.2022</td> <td>6000000000</td> <td>Saved </td> </tr> <tr> <td>5000000000</td> <td>Test 4 step off line in sus portal</td> <td>Open Tendering</td> <td>Published</td> <td></td> <td>15.02.2022</td> <td>6000000000</td> <td>Submitted </td> </tr> </tbody> </table> <ul style="list-style-type: none"> Bidders who have submitted their bids should not click on WITHDRAW but click on EDIT to amend their bid response with appropriate changes if they desire to do so. Manuals to guide on the bidding process are accessible via the KenGen Tenders Portal. 	Event Number	Event Description	Event Type	Event Status	Start Date	End Date	Response Number	Response Status	5000000000	Test Bid Invite Notification to Bidders	Open Tendering	Published		22.09.2022	6000000000	Saved 	5000000000	Test 4 step off line in sus portal	Open Tendering	Published		15.02.2022	6000000000	Submitted 
Event Number	Event Description	Event Type	Event Status	Start Date	End Date	Response Number	Response Status																		
5000000000	Test Bid Invite Notification to Bidders	Open Tendering	Published		22.09.2022	6000000000	Saved 																		
5000000000	Test 4 step off line in sus portal	Open Tendering	Published		15.02.2022	6000000000	Submitted 																		
ITT 3.0	<p>Eligibility</p> <p>This tender is open to Women Enterprises.</p> <p>eligibility and qualifications</p> <p>Proof of eligibility, qualification documents of evidence (see evaluation criteria).</p>																								
ITT 3.1	<p>Maximum number of members in the Joint Venture (JV) shall be three (3). No firm can participants in more than one JV for purposes of this tender. The JV Must be of the same Women AGPO Group.</p>																								
ITT 3.7	<p>A list of debarred firms and individuals is available on the PPRA’s website: www.ppra.go.ke</p>																								
ITT 3.11	<p>Tenderers shall be required to be registered with e- procurement https://supplierregistration.kengen.co.ke:4302/slc_selfreg(bD11biZjPTMwMCZkPW1pbg==)/bspwdapplication.do#VIEW_ANCHOR-ROS_TOP This is for suppliers registering for the first time to enable bidding via e-procurement portal.</p>																								
<p>B. Contents of Tendering Document</p>																									
ITT 6.1	<p>(a) Address where to send enquiries is Attention:</p> <p><i>General Manager, Supply Chain, Kenya Electricity Generating Company PLC, 9th Floor, KenGen Pension Plaza II, Kolobot Road, Parklands, P.O. Box 47936, 00100 NAIROBI.</i></p> <p>tenders@kengen.co.ke; cc ejuma@kengen.co.ke; tnjau@kengen.co.ke, wkimote@kengen.co.ke;</p>																								
ITT 6.2	<p>A pre-tender conference will not be held</p>																								
ITT 6.3	<p>The questions/ Requests for clarification to reach the Procuring Entity not later</p>																								

ITT Reference	Particulars Of Appendix To Instructions To Tenders
	than Entity not later than 7 days before the tender closing date Web page: [www.kengen.co.ke].
	C. Preparation of Tenders
ITT 10 (j)	The Tenderer shall submit the following additional documents in its Tender: N/a
ITT 12.1	Alternative Tenders <i>shall not be considered</i>
ITT 13.0	Tender Prices Prices indicated in the tender form shall be inclusive of all applicable taxes and insurance
ITT 13.5	The prices quoted by the Tenderer shall not be subject to adjustment during the performance of the Contract and not subject of variation. A Tender submitted with an adjustable price quotation shall be treated as non- responsive and shall be rejected.
ITT 13.8 (a) (i) and (iii)	Place of final destination: <i>[DDP - Kipevu Power Station]</i>
ITT 13.8 (a) (iii)	Place of final destination: <i>[DDP - Kipevu Power Station]</i>
ITT 14.2	Foreign currency requirements allowed in a free convertible currency
ITT 15.4	Period of time the Goods are expected to be functioning (for the purpose of spare parts): 12 Months
ITT 16.2 (a)	Manufacturer's authorization is: "required"
ITT 17.1	The Tender validity period shall be 126 days from the date of tender opening.
ITT 17.3	The Number of days beyond the expiry of the initial tender validity period will be 30 days.
ITT 18.1	A Tender Security shall not be required. A Tender-Securing Declaration shall be required. The tenderer will be required to complete a Duly filled, signed and stamped Tender Securing Declaration form attached in the standard forms of the tender document.
ITT 19.1	In addition to the original copy of the Tender, the number of copies is Not Applicable
ITT 19.3	The written confirmation of authorization to sign on behalf of the Tenderer shall consist of: Tender specific a Power of Attorney
	D. Submission and Opening of Tenders
ITT 21.1	For Tender submission purposes only, the Procuring Entity's address is: 1. For suppliers registering for the first time using the link https://supplierregistration.kengen.co.ke:4302/slc_selfreg(bd11biZjPTMwMCZkPW1pbg==)/bspwdapplication.do#VIEW_ANCHOR-ROS_TOP ensure the "Public Tender" checkbox is ticked so that the login details are sent to suppliers automatically.  2. It is a mandatory requirement all Documents MUST be uploaded to the SRM System through the link https://eprocurement.kengen.co.ke:50001/irj/portal found on www.kengen.co.ke .  After clicking on the Event Number, then click on Register (for Open tenders), then click on 'Create Response', bidders to click on 'Technical RFX Response' tab to access the cfolder page to upload your document.

ITT Reference	Particulars Of Appendix To Instructions To Tenders																								
	<p><u>Instructions to Bidders: Caution on Uploading Bid Documents</u></p> <p>a. Preferred Submission Method: Bidders are advised to use the C-Folder for submitting their tenders. This platform is specifically designed to handle bulky technical bid documents of up to 99MB per file.</p> <p>b. Exceeding File Size Limit: In the event that the bid response exceeds the 99MB limit: -</p> <p>i. Bidders should try to compress the pdf file first to file size less than 99MB and if compressing doesn't reduce the file size consider option (ii) below.</p> <p>ii. Split the documents into two or more separate files before submission. This ensures the integrity of the tendering process and accurate evaluation of all necessary information.</p> <p>c. Bids uploaded on Notes and Attachments" Tab may have a transmission failure and the bid may not be successfully received through the system and KenGen will not be held accountable for failure to transmit on eProcurement portal.</p> <p>d. Assistance and Inquiries: For any questions or further assistance, bidders are encouraged to reach out to the team at least 24 hours before submission deadline through eprocurement@kengen.co.ke; or tenders@kengen.co.ke; or visit our offices through the Karibu Centre.</p> <p>N/B: Your cooperation is highly appreciated, and the organization looks forward to receiving your bids.</p> <ul style="list-style-type: none"> Prices MUST be entered under item tab of the RfX and MUST be similar to the prices in the price Schedule.  <ul style="list-style-type: none"> Bidders should confirm on the supplier portal that the status of their RfX response shows "Submitted" and not "Saved" to ensure their RfX response is submitted. <table border="1" data-bbox="453 1330 1437 1429"> <thead> <tr> <th>Event Number</th> <th>Event Description</th> <th>Event Type</th> <th>Event Status</th> <th>Start Date</th> <th>End Date</th> <th>Response Number</th> <th>Response Status</th> </tr> </thead> <tbody> <tr> <td>5000000000</td> <td>Test Bid Invite Submission to Bidders</td> <td>Open Tendering</td> <td>Published</td> <td></td> <td>22.09.2023</td> <td>6000000000</td> <td>Saved </td> </tr> <tr> <td>5000000000</td> <td>Test 4 step off line in sus portal</td> <td>Open Tendering</td> <td>Published</td> <td></td> <td>15.02.2024</td> <td>6000000000</td> <td>Submitted </td> </tr> </tbody> </table> <ul style="list-style-type: none"> Bidders who have submitted their bids should not click on WITHDRAW but click on EDIT to amend their bid response with appropriate changes if they desire to do so. Manuals to guide on the bidding process are accessible via the KenGen Tenders Portal.  <p>The deadline for Tender submission is:</p> <p>Date: 7th May, 2024</p> <p>Time: 2.00 p.m.</p>	Event Number	Event Description	Event Type	Event Status	Start Date	End Date	Response Number	Response Status	5000000000	Test Bid Invite Submission to Bidders	Open Tendering	Published		22.09.2023	6000000000	Saved 	5000000000	Test 4 step off line in sus portal	Open Tendering	Published		15.02.2024	6000000000	Submitted 
Event Number	Event Description	Event Type	Event Status	Start Date	End Date	Response Number	Response Status																		
5000000000	Test Bid Invite Submission to Bidders	Open Tendering	Published		22.09.2023	6000000000	Saved 																		
5000000000	Test 4 step off line in sus portal	Open Tendering	Published		15.02.2024	6000000000	Submitted 																		
ITT 24.1	<p>The Tender opening shall take place at:</p> <p>Kenya Electricity Generating Company PLC, 6th Floor, KenGen Pension Plaza II, Kolobot Road, Parklands, P.O. Box 47936, 00100 NAIROBI.</p>																								

ITT Reference	Particulars Of Appendix To Instructions To Tenders
	<p>Tender Opening date and time 7th May, 2024 at 2.30 p.m.</p> <p>Where bidders or their representatives choose to attend the bid opening, KenGen shall limit the persons to a maximum of 5 people, whom shall be nominated by the bidders present for the opening session.</p> <ul style="list-style-type: none"> •Screening and registration of all attendees shall take place in all sessions. •Failure to attend the bid opening shall not invalidate the process. <p>Bidders can request for the tender opening minutes of the tender opening session through the following email address tenders@kengen.co.ke</p>
E. Evaluation and Comparison of Tenders	
ITT 31.1	Where other currencies are used, the procuring entity shall convert these Currencies to Kenya Shillings using the selling exchange rate on the date of tender closing provided by the Central Bank of Kenya before comparing all the responsive tenders.
ITT 32.3	A margin of preference and/or reservation <i>shall not</i> apply.
	<p>Preliminary Examination</p> <p>Tender sum as submitted and read out during tender opening is absolute and shall not be subject to correction, adjustment or amendment in any way Sec.82 of PPADA 2015, Subject to section 79(2)(b) of the Act, any error in the submitted tender arising from a miscalculation of unit price, quantity, subtotal and total bid price shall be considered as a major deviation that affects substance of the tender and shall lead to disqualification of the tender as non-responsive.</p>
	<p>Due Diligence</p> <p>KenGen may at its own discretion conduct due diligence on the eligible bidders to establish their ability to perform the contract before award of the contract.</p>
F. Award of Contract	
ITT 47.3	Performance security shall be at 1% of the Contract Price where the contract value is above five million shillings.
ITT 49.1	The procedures for making a Procurement-related Complaint are detailed in the “Notice of Intention to Award the Contract” herein and are also available from the PPRA Website www.ppra.go.ke .

SECTION III - EVALUATION AND QUALIFICATION CRITERIA

1. General Provisions

1.1. Wherever a Tenderer is required to state a monetary amount, Tenderers should indicate the Kenya Shilling equivalent using the rate of exchange determined as follows:

- For business turnover or financial data required for each year - Exchange rate prevailing on the last day of the respective calendar year (in which the amounts for that year is to be converted) was originally established.
- Value of single contract - Exchange rate prevailing on the date of the contract signature.
- Exchange rates shall be taken from the publicly available source identified in the ITT 14.3. Any error in determining the exchange rates in the Tender may be corrected by the Procuring Entity.

1.2. This section contains the criteria that the Procuring Entity shall use to evaluate tender and qualify tenderers. No other factors, methods or criteria shall be used other than those specified in this tender document. The Tenderer shall provide all the information requested in the forms included in Section IV, Tendering Forms. The Procuring Entity should use the Standard Tender Evaluation Report for Goods and Works for evaluating Tenders.

REGISTRATION AND BIDDING PROCESS

- For suppliers registering for the first time using the link [https://supplierregistration.kengen.co.ke:4302/slc_selfreg\(bd11biZjPTMwMCZkPW1pbg==\)/bspwdapplication.do#VIEW_ANCHOR-ROS_TOP](https://supplierregistration.kengen.co.ke:4302/slc_selfreg(bd11biZjPTMwMCZkPW1pbg==)/bspwdapplication.do#VIEW_ANCHOR-ROS_TOP) ensure the “Public Tender” checkbox is ticked so that the login details are sent to suppliers automatically.

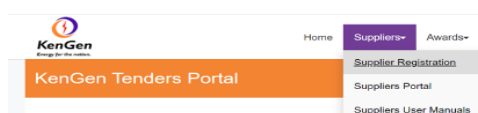

- It is a mandatory requirement all Documents MUST be uploaded to the SRM System through the link <https://eprocurement.kengen.co.ke:50001/irj/> portal found on www.kengen.co.ke.

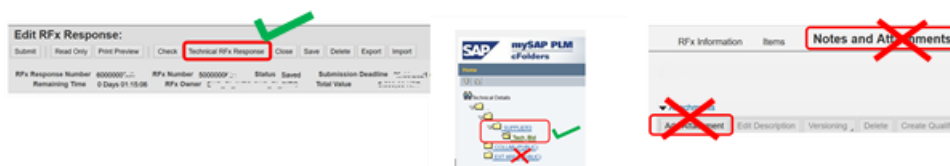

- Prices **MUST** be entered under item tab of the RfX and **MUST** be similar to the prices in the price/BoQ Schedule.

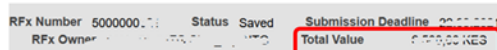

After clicking on the Event Number, then click on Register (for Open tenders), then click on ‘Create Response’, bidders to click on ‘Technical RfX Response’ tab to access the cfolder page to upload your document.

Instructions to Bidders: Caution on Uploading Bid Documents

a. Preferred Submission Method: Bidders are advised to use the C-Folder for submitting their tenders. This platform is specifically designed to handle bulky technical bid documents of up to **99MB per file**.

b. Exceeding File Size Limit: In the event that the bid response exceeds the **99MB limit**: -

- Bidders should try to compress the **pdf file first to file size less than 99MB** and if compressing doesn't

reduce the file size consider option (ii) below.

ii. Split the documents into two or more separate files before submission. This ensures the integrity of the tendering process and accurate evaluation of all necessary information.

c. Bids uploaded on “Notes and Attachments Tab” may have a transmission failure and the bid may not be successfully received through the system and KenGen will not be held accountable for failure to transmit on eProcurement portal.

d. Assistance and Inquiries: For any questions or further assistance, bidders are encouraged to reach out to the team at least 24 hours before submission deadline through eprocurement@kengen.co.ke ; or tenders@kengen.co.ke ; or visit our offices through the Karibu Centre.

- Bidders should confirm on the supplier portal that the status of their RFX response shows “Submitted” and not “Saved” to ensure their RFX response is submitted.

Event Number	Event Description	Event Type	Event Status	Start Date	End Date	Response Number	Response Status
5000000000000000	Test Bid Invite to Bidders	Open Tendering	Published		22.09.2024	6000000000000000	Saved
5000000000000000	Test 4 In sus portal	Open Tendering	Published		15.02.2024	6000000000000000	Submitted

- Bidders who have submitted their bids should not click on **WITHDRAW** but click on **EDIT** to amend their bid response with appropriate changes if they desire to do so.
- Manuals to guide on the bidding process are accessible via the KenGen Tenders Portal.

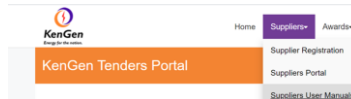

- Bidders to note that **system challenges/support** related to bid submission issues shall be **addressed to eprocurement@kengen.co.ke** tender closing date and time.

2. Evaluation of Tenders (ITT 33)

2.1. Successful Tender or Tenders

The Procuring Entity shall use the criteria and methodologies listed in this Section to evaluate Tenders. By applying these criteria and methodologies, the Procuring Entity shall determine the successful Tender or Tenders which has/have been determined to:

- be substantially responsive to the tender documents;
- offer the lowest evaluated cost to the Procuring Entity for all items of Goods to be procured based on either a single Contract or all multiple Contracts combined, as the case may be, in accordance with the ITT 13.6 inviting Tender prices and discounts, and provisions made of the Tender Document for evaluation of tenders and award of contract (s); and
- be offered by Tenderer or Tenderers that substantially meet the qualification criteria applicable for Contract or combined Contracts for which they are selected.

2.2. Evaluation of Tenders

Preliminary examination for Determination of Responsiveness

The Procuring Entity will start by examining all tenders to ensure they meet in all respects the eligibility criteria and other mandatory requirements in the ITT, and that the tender is complete in all aspects in meeting the requirements provided for in the preliminary evaluation criteria outlined below. The Standard Tender Evaluation Report Document for Goods and Works for evaluating Tenders provides very clear guide on how to deal with review of these requirements. Tenders that do not pass the Preliminary Examination will be considered non-responsive and will not be considered further.

STAGE 1: MANDATORY REQUIREMENTS

The following mandatory requirements must be met notwithstanding other requirements in the tender document:

No	MANDATORY REQUIREMENTS
MR 1	Valid copy of Registration Certificate /Certificate of Incorporation.
MR 2	Valid copy of the business permit.
MR 3	Valid tax compliance/ exemption certificate(s)/PIN Certificate
MR 4	Copy of a valid CR 12 issued within 6 months of tender closure (where applicable)/Not Applicable to sole Proprietors, but attach copy of ID.
MR 5	Duly filled, signed & stamped Tenderer's Eligibility; Confidential Business Questionnaire
MR 6	Duly filled and signed and stamped tender form.
MR 7	Duly filled and signed and stamped price schedule.
MR 8	Dully filled and stamped Addendum(s) and Clarification(s) issued must be attached (Where Applicable).
MR 9	The Tender MUST be submitted in the required format and serialized on each page of the bid submitted, Sec.74.1.i. of the PPADA, 2015.
MR 10	The tender has been dully signed by the person lawfully authorized to do so through the power of Attorney.
MR 11	Tender documents Must be submitted through our e-procurement platform found at www.kengen.co.ke (https://eprocurement.kengen.co.ke:50001/irj/portal as indicated in Tender Data Sheet (TDS))
MR 12	Valid & current AGPO certificate for Women – Enterprises
MR 13	Duly filled and signed Tenderer Information Form
MR 14	Duly filled signed and stamped Self Declaration form that the tenderer is not debarred in the matter of PPADA 2015.
MR 15	Duly filled signed and stamped Self Declaration form that the tenderer will not engage in any corrupt or Fraudulent Practice.
MR 16	Provide proof of Authorization from manufacturer by providing a Manufacturer's Authorization Letter (if bidder is not the manufacturer)
MR 17	Duly filled, signed and stamped Declaration and Commitment to the Code of Ethics
MR 18	Duly filled and signed Certificate of Independent Tender Determination
MR 19	Tender security not Required for this tender However, the tenderer will be required to complete a Duly filled, signed and stamped Tender Securing Declaration form attached in the standard forms of the tender document.
MR 20	Duly filled, signed and stamped Declaration and Commitment to The Code of Ethics
MR 21	Twelve months (12) Warranty for spares from C.C.JENSEN A/S
MR 22	Those who do not have a capacity can enter into a Joint venture. (where Applicable) <ul style="list-style-type: none"> ▪ In case of JV, Joint venture Agreement MUST be Dully filled, signed and stamped. ▪ The Maximum number of Members in the JV should be Three (3). ▪ Duly filled Tenderer's JV Members Information Form. ▪ Note: In case of Joint venture (JV), Mandatory requirements; MR 1, MR 2, MR 3, MR 4, MR 5 and MR 12 Shall be applicable to all members in the Joint Venture (JV). ▪ In of a case of a Joint Venture, the members must provide a notarized power of attorney, nominating one member who will be authorized to act their behalf. The nominated member will have the authority to exercise all rights and fulfill all obligations related to the Contract with the Procuring Entity. This includes without limitation, receiving instructions and handling payments from the Procuring Entity.

2.3. Evaluation of Technical aspects of the Tender

The Procuring Entity shall evaluate the Technical aspects of the Tender to determine compliance with the Procuring Entity's requirements under Section V 'Schedule of Requirement' and whether the Tenders are substantially responsive to the Technical Specifications and other Requirements.

STAGE 2. TECHNICAL EVALUATION ON CAPACITY TO DELIVER THE CONTRACT

Technical evaluation shall be carried out only if the tender is determined to be responsive to the preliminary examination.

Bidder must demonstrate conformance to all the technical specifications and requirements as per section V of the tender document.

The Technical Evaluation will also be based on compliance with the technical specifications set out in Section V of this tender document.

1.1.2 STAGE 2: TECHNICAL EVALUATION CRITERIA

No.	Item description	Bidder's Response (Yes/No)
TR 1	Demonstrate conformity of the service and spares availed to the required technical specification	
TR 2	Provide spare parts catalogues, bulletins as well as operation and maintenance manuals for the hydraulic and other equipment required. These should be stamped by the manufacturer	

Bidder must be responsive on ALL the above parameters to be considered qualified for financial evaluation.

1.1.3 STAGE 3. FINANCIAL EVALUATION

Financial evaluation shall involve checking completeness of financial bids

- Presence of a duly filled signed and stamped tender form and price schedule.
- Award shall be based on the **lowest evaluated compliant Bidder.**
- All prices must be inclusive of all the applicable taxes.
- Tender sum as submitted and read out during tender opening is absolute and final and shall not be subject to correction, adjustment or amendment major deviation shall result in disqualification.

Any errors in the submitted tender arising from a miscalculation of unit price, quantity, subtotal and total bid price shall be considered as a major deviation that affects the substance of the tender and shall lead to disqualification of the tender as non-responsive (ref Section 74(2) of Public Procurement and Asset Disposal Regulations 2020)

1.1.4 STAGE 4. DUE DILLIGENCE

KenGen shall prior to award of the tender determine to its satisfaction whether the selected bids will qualify to perform the contract satisfactorily by carrying out a due diligence visit as required.

SECTION IV - TENDERING FORMS

Form of Tender Tenderer Information

Form Tenderer JV Members Information Form

Price Schedule: Goods Manufactured Outside Kenya, to be Imported Price Schedule:

Goods Manufactured outside Kenya, already imported Price Schedule:

Goods Manufactured in Kenya

Price and Completion Schedule – Related Services

Form of Tender Security – Demand Guarantee

Form of Tender Security (Tender Bond)

Form of Tender-Securing Declaration

Manufacturer's Authorization Form

FORM OF TENDER
(Amended and issued pursuant to PPRA CIRCULAR No. 02/2022)

INSTRUCTIONS TO TENDERERS

- i) *All italicized text is to help the Tenderer in preparing this form.*
- ii) *The Tenderer must prepare this Form of Tender on stationery with its letterhead clearly showing the Tenderer's complete name and business address. Tenderers are reminded that this is a mandatory requirement.*
- iii) *Tenderer must complete and sign CERTIFICATE OF INDEPENDENT TENDER DETERMINATION and the SELF DECLARATION FORMS OF THE TENDERER as listed under (s) below.*

Date of this Tender submission:.....*[insert date (as day, month and year) of Tender submission]*

Tender Name and Identification:.....*[insert identification]*

Alternative No.:.....*[insert identification No if this is a Tender for an alternative]*

To: *[Insert complete name of Procuring Entity]*

- a) **No reservations:** We have examined and have no reservations to the Tendering document, including Addenda issued in accordance with Instructions to tenderers (ITT 7);
- b) **Eligibility:** We meet the eligibility requirements and have no conflict of interest in accordance with ITT 3;
- c) **Tender/Proposal-Securing Declaration:** We have not been suspended nor declared ineligible by the Procuring Entity based on execution of a Tender-Securing Declaration. Or Proposal-Securing Declaration in Kenya in accordance with ITT 3.6;
- d) **Conformity:** We offer to supply in conformity with the Tendering document and in accordance with the Delivery Schedules specified in the Schedule of Requirements the following Goods: *[insert a brief description of the Goods and Related Services];*
- e) **Tender Price:** The total price of our Tender, excluding any discounts offered in item (f) below is:

Option 1, in case of one lot: Total price is: *[insert the total price of the Tender in words and figures, indicating the various amounts and the respective currencies];*

or

Option 2, in case of multiple lots: (a) Total price of each lot *[insert the total price of each lot in words and figures, indicating the various amounts and the respective currencies];* and (b) Total price of all lots (sum of all lots) *[insert the total price of all lots in words and figures, indicating the various amounts and the respective currencies];*

f) **Discounts:** The discounts offered and the methodology for their application are:

i) The discounts offered are: *[Specify in detail each discount offered.]*

ii) The exact method of calculations to determine the net price after application of discounts are shown below: *[Specify in detail the method that shall be used to apply the discounts];*

g) **Tender Validity Period:** Our Tender shall be valid for the period specified in TDS 17.1 (as amended, if applicable) from the date fixed for the Tender submission deadline specified in TDS 21.1 (as amended, if applicable), and it shall remain binding upon us and may be accepted at any time before the expiration of that period;

- h) **Performance Security:** If our Tender is accepted, we commit to obtain a performance security in accordance with the Tendering document;
- i) **One Tender per tenderer:** We are not submitting any other Tender(s) as an individual tenderer, and we are not participating in any other Tender(s) as a Joint Venture member, or as a subcontractor, and meet the requirements of ITT 3.9, other than alternative Tenders submitted in accordance with ITT 12;
- j) **Suspension and Debarment:** We, along with any of our subcontractors, suppliers, consultants, manufacturers, or service providers for any part of the contract, are not subject to, and not controlled by any entity or individual that is subject to, a temporary suspension or a debarment imposed by the Procuring Entity. Further, we are not ineligible under the Kenya laws or official regulations or pursuant to a decision of the United Nations Security Council;
- k) **State-owned enterprise or institution:** *[select the appropriate option and delete the other] [We are not a state- owned enterprise or institution] / [We are a state-owned enterprise or institution but meet the requirements of ITT 3.7];*
- l) **Commissions, gratuities, fees:** We have paid, or will pay the following commissions, gratuities, or fees with respect to the Tendering process or execution of the Contract: *[insert complete name of each Recipient, its full address, the reason for which each commission or gratuity was paid and the amount and currency of each such commission or gratuity]*

Name of Recipient	Address	Reason	Amount

(If none has been paid or is to be paid, indicate “none.”)

- m) **Binding Contract:** We understand that this Tender, together with your written acceptance thereof included in your Letter of Acceptance, shall constitute a binding contract between us, until a formal contract is prepared and executed;
- n) **Procuring Entity Not Bound to Accept:** We understand that you are not bound to accept the lowest evaluated cost Tender, the Best Evaluated Tender or any other Tender that you may receive; and
- o) **Fraud and Corruption:** We hereby certify that we have taken steps to ensure that no person acting for us or on our behalf engages in any type of Fraud and Corruption.
- p) **Code of Ethical Conduct:** We undertake to adhere by the Code of Ethics for Persons Participating in Public Procurement and Asset Disposal, copy available from _____ *(specify website)* during the procurement process and the execution of any resulting contract.
- q) **Collusive practices:** We hereby certify and confirm that the tender is genuine, non-collusive and made with the intention of accepting the contract if awarded. To this effect we have signed the “Certificate of Independent tender Determination” attached below.
- r) **Beneficial Ownership Information:** We commit to provide to the procuring entity the Beneficial Ownership Information in conformity with the Beneficial Ownership Disclosure Form upon receipt of notification of intention to enter into a contract in the event we are the successful tenderer in this subject procurement proceeding.
- s) We, the Tenderer, have duly completed, signed and stamped the following Forms as part of our Tender:
 - a) Tenderer's Eligibility; Confidential Business Questionnaire – to establish we are not in any conflict to interest;

- b) Certificate of Independent Tender Determination – to declare that we completed the tender without colluding with other tenderers;
- c) Self-Declaration of the Tenderer – to declare that we will, if awarded a contract, not engage in any form of fraud and corruption; and
- d) Declaration and Commitment to the Code of Ethics for Persons Participating in Public Procurement and Asset Disposal.

Further, we confirm that we have read and understood the full content and scope of fraud and corruption as informed in “**Appendix 1- Fraud and Corruption**” attached to the Form of Tender.

Name of the tenderer: **[insert complete name of the tenderer]*

Name of the person duly authorized to sign the Tender on behalf of the tenderer: ***[insert complete name of person duly authorized to sign the Tender]*

Title of the person signing the Tender: *[insert complete title of the person signing the Tender]*

Signature of the person named above: *[insert signature of person whose name and capacity are shown above]* **Date signed** *[insert date of signing]* **day of** *[insert month]*, *[insert year]*

***:** In the case of the Tender submitted by a Joint Venture specify the name of the Joint Venture as tenderer.

****:** Person signing the Tender shall have the power of attorney given by the tenderer. The power of attorney shall be attached with the Tender Schedules.

I, the undersigned, in submitting the accompanying Letter of Tender to the _____

[Name of Procuring Entity] for: _____

[Name and number of tender] in response to the request for tenders made by: _____

[Name of Tenderer] do hereby make the following statements that I certify to be true and complete in every respect:

I certify, on behalf of _____ [Name of Tenderer] that:

1. I have read and I understand the contents of this Certificate;
2. I understand that the Tender will be disqualified if this Certificate is found not to be true and complete in every respect;
3. I am the authorized representative of the Tenderer with authority to sign this Certificate, and to submit the Tender on behalf of the Tenderer;
4. For the purposes of this Certificate and the Tender, I understand that the word "competitor" shall include any individual or organization, other than the Tenderer, whether or not affiliated with the Tenderer, who:
 - a) has been requested to submit a Tender in response to this request for tenders;
 - b) could potentially submit a tender in response to this request for tenders, based on their qualifications, abilities or experience;
5. The Tenderer discloses that [check one of the following, as applicable]:
 - a) The Tenderer has arrived at the Tender independently from, and without consultation, communication, agreement or arrangement with, any competitor;
 - b) the Tenderer has entered into consultations, communications, agreements or arrangements with one or more competitors regarding this request for tenders, and the Tenderer discloses, in the attached document(s), complete details thereof, including the names of the competitors and the nature of, and reasons for, such consultations, communications, agreements or arrangements;
6. In particular, without limiting the generality of paragraphs (5)(a) or (5)(b) above, there has been no consultation, communication, agreement or arrangement with any competitor regarding:
 - a) prices;
 - b) methods, factors or formulas used to calculate prices;
 - c) the intention or decision to submit, or not to submit, a tender; or
 - d) the submission of a tender which does not meet the specifications of the request for Tenders; except as specifically disclosed pursuant to paragraph (5)(b) above;
7. In addition, there has been no consultation, communication, agreement or arrangement with any competitor regarding the quality, quantity, specifications or delivery particulars of the works or services to which this request for tenders relates, except as specifically authorized by the procuring authority or as specifically disclosed pursuant to paragraph (5)(b) above;
8. the terms of the Tender have not been, and will not be, knowingly disclosed by the Tenderer, directly or indirectly, to any competitor, prior to the date and time of the official tender opening, or of the awarding of the Contract, whichever comes first, unless otherwise required by law or as specifically disclosed pursuant to paragraph (5)(b) above.

Name_ Title_ Date_ [Name, title and signature of authorized agent of Tenderer and Date]

SELF-DECLARATION FORMS

FORM SD1

SELF DECLARATION THAT THE PERSON/TENDERER IS NOT DEBARRED IN THE MATTER OF THE PUBLIC PROCUREMENT AND ASSET DISPOSAL ACT 2015.

I of Post Office Box.....being a resident of in the Republic of.....do hereby make a statement as follows:-

1. THAT I am the Company Secretary/ Chief Executive/Managing Director/Principal Officer/Director of (*insert name of the Company*) who is a Bidder in respect of **Tender No.** for..... (*insert tender title/description*) for.....(*insert name of the Procuring entity*) and duly authorized and competent to make this statement.
2. THAT the aforesaid Bidder, its Directors and subcontractors have not been debarred from participating in procurement proceeding under Part IV of the Act.
3. THAT what is deponed to herein above is true to the best of my knowledge, information and belief.

.....
(Title)	(Signature)	(Date)
Bidder Official Stamp		

FORM SD2
SELF DECLARATION THAT THE PERSON/TENDERER WILL NOT ENGAGE IN ANY
CORRUPT OR FRAUDULENT PRACTICE

I, of P.O. Box.....being a resident of..... in the Republic of do hereby make a statement as follows:-

1. THAT I am the Chief Executive/Managing Director/Principal Officer/Director of..... (*insert name of the Company*) who is a Bidder in respect of **Tender No.** for..... (*Insert tender title/description*) for..... (*insert name of the Procuring entity*) and duly authorized and competent to make this statement.
2. THAT the aforesaid Bidder, its servants and/or agents /subcontractors will not engage in any corrupt or fraudulent practice and has not been requested to pay any inducement to any member of the Board, Management, Staff and/or employees and/or agents of(*insert name of the Procuring entity*) which is the procuring entity.
3. THAT the aforesaid Bidder, its servants and/or agents /subcontractors have not offered any inducement to any member of the Board, Management, Staff and/or employees and/or agents of(*name of the procuring entity*).
4. THAT the aforesaid Bidder will not engage/has not engaged in any corrosive practice with other bidders participating in the subject tender.
5. THAT what is deponed to herein above is true to the best of my knowledge information and belief.

.....
(Title)	(Signature)	(Date)
Bidder Official Stamp		

1.1.6 DECLARATION AND COMMITMENT TO THE CODE OF ETHICS

I..... (Person) on behalf of
(Name of the Business/ Company/Firm).....declare that I
have read and fully understood the contents of the Public Procurement & Asset Disposal
Act, 2015, Regulations and the Code of Ethics for persons participating in Public
Procurement and Asset Disposal and my responsibilities under the Code.

I do hereby commit to abide by the provisions of the Code of Ethics for persons
participating in Public Procurement and Asset Disposal.

Name of Authorized signatory.....

Sign.....

Position.....

Office address..... Telephone.....

E-mail.....

Name of the Firm/Company.....

Date.....

(Company Seal/ Rubber Stamp where applicable)

Witness

Name

Sign.....

Date.....

FORMAT OF POWER OF ATTORNEY

We..... (name and address of the registered office) do hereby constitute, appoint and authorize Mr. / Mrs. / Ms (name and residential address) who is presently employed with us and holding the position of as our attorney, to do in our name and on our behalf, all such acts, deeds and things necessary in connection with or incidental to our proposal for the project/goods/works/services“.....”, including signing and submission of all documents and providing information / responses to the Kenya Electricity Generating Company PLC, ("KenGen"), representing us in all matters before KenGen, and generally dealing with KenGen in all matters in connection with our Proposal for the said project/goods/works/services.

We hereby agree to ratify all acts, deeds and things lawfully done by our said attorney pursuant to this Power of Attorney and that all acts, deeds and things done by our aforesaid attorney shall and shall always be deemed to have been done by us

..... (Signature)(Name, Title and Address) Accepted

..... (Signature)(Name, Title and Address of the Attorney)

APPENDIX 1- FRAUD AND CORRUPTION

(Appendix 1 shall not be modified)

1. Purpose

- 1.1 The Government of Kenya's Anti-Corruption and Economic Crime laws and their sanction's policies and procedures, Public Procurement and Asset Disposal Act (*no. 33 of 2015*) and its Regulation, and any other Kenya's Acts or Regulations related to Fraud and Corruption, and similar offences, shall apply with respect to Public Procurement Processes and Contracts that are governed by the laws of Kenya.

2. Requirements

- 2.1 The Government of Kenya requires that all parties including Procuring Entities, Tenderers, (applicants/proposers), Consultants, Contractors and Suppliers; any Sub-contractors, Sub-consultants, Service providers or Suppliers; any Agents (whether declared or not); and any of their Personnel, involved and engaged in procurement under Kenya's Laws and Regulation, observe the highest standard of ethics during the procurement process, selection and contract execution of all contracts, and refrain from Fraud and Corruption and fully comply with Kenya's laws and Regulations as per paragraphs 1.1 above.

- 2.2 Kenya's public procurement and asset disposal act (*no. 33 of 2015*) under Section 66 describes rules to be followed and actions to be taken in dealing with Corrupt, Coercive, Obstructive, Collusive or Fraudulent practices, and Conflicts of Interest in procurement including consequences for offences committed. A few of the provisions noted below highlight Kenya's policy of no tolerance for such practices and behavior:

- 1) a person to whom this Act applies shall not be involved in any corrupt, coercive, obstructive, collusive or fraudulent practice; or conflicts of interest in any procurement or asset disposal proceeding;
- 2) A person referred to under subsection (1) who contravenes the provisions of that subsection commits an offence;
- 3) Without limiting the generality of the subsection (1) and (2), the person shall be—
 - a) disqualified from entering into a contract for a procurement or asset disposal proceeding; or
 - b) if a contract has already been entered into with the person, the contract shall be voidable;
- 4) The voiding of a contract by the procuring entity under subsection (7) does not limit any legal remedy the procuring entity may have;
- 5) An employee or agent of the procuring entity or a member of the Board or committee of the procuring entity who has a conflict of interest with respect to a procurement:-
 - a) shall not take part in the procurement proceedings;
 - b) shall not, after a procurement contract has been entered into, take part in any decision relating to the procurement or contract; and
 - c) shall not be a subcontractor for the bidder to whom was awarded contract, or a member of the group of bidders to whom the contract was awarded, but the subcontractor appointed shall meet all the requirements of this Act.
- 6) An employee, agent or member described in subsection (1) who refrains from doing anything prohibited under that subsection, but for that subsection, would have been within his or her duties shall disclose the conflict of interest to the procuring entity;
- 7) If a person contravenes subsection (1) with respect to a conflict of interest described in subsection (5)(a) and the contract is awarded to the person or his relative or to another person in whom one of them had a direct or indirect pecuniary interest, the contract shall be terminated and all costs incurred by the public entity shall be made good by the awarding officer. Etc.

- 2.3 In compliance with Kenya's laws, regulations and policies mentioned above, the Procuring Entity:

- a) Defines broadly, for the purposes of the above provisions, the terms set forth below as follows:
- i) “corrupt practice” is the offering, giving, receiving, or soliciting, directly or indirectly, of anything of value to influence improperly the actions of another party;
 - ii) “fraudulent practice” is any act or omission, including misrepresentation, that knowingly or recklessly misleads, or attempts to mislead, a party to obtain financial or other benefit or to avoid an obligation;
 - iii) “collusive practice” is an arrangement between two or more parties designed to achieve an improper purpose, including to influence improperly the actions of another party;
 - iv) “coercive practice” is impairing or harming, or threatening to impair or harm, directly or indirectly, any party or the property of the party to influence improperly the actions of a party;
 - v) “obstructive practice” is:
 - deliberately destroying, falsifying, altering, or concealing of evidence material to the investigation or making false statements to investigators in order to materially impede investigation by Public Procurement Regulatory Authority (PPRA) or any other appropriate authority appointed by Government of Kenya into allegations of a corrupt, fraudulent, coercive, or collusive practice; and/or threatening, harassing, or intimidating any party to prevent it from disclosing its knowledge of matters relevant to the investigation or from pursuing the investigation; or
 - acts intended to materially impede the exercise of the PPRA's or the appointed authority's inspection and audit rights provided for under paragraph 2.3 e. below.
- b) Defines more specifically, in accordance with the above procurement Act provisions set forth for fraudulent and collusive practices as follows:
- "fraudulent practice" includes a misrepresentation of fact in order to influence a procurement or disposal process or the exercise of a contract to the detriment of the procuring entity or the tenderer or the contractor, and includes collusive practices amongst tenderers prior to or after tender submission designed to establish tender prices at artificial non-competitive levels and to deprive the procuring entity of the benefits of free and open competition.
- c) Rejects a proposal for award¹ of a contract if PPRA determines that the firm or individual recommended for award, any of its personnel, or its agents, or its sub-consultants, sub-contractors, service providers, suppliers and/ or their employees, has, directly or indirectly, engaged in corrupt, fraudulent, collusive, coercive, or obstructive practices in competing for the contract in question;
 - d) Pursuant to the Kenya's above stated Acts and Regulations, may sanction or debar or recommend to appropriate authority (ies) for sanctioning and debarment of a firm or individual, as applicable under the Acts and Regulations;
 - e) Requires that a clause be included in Tender documents and Request for Proposal documents requiring (i) Tenderers (applicants/proposers), Consultants, Contractors, and Suppliers, and their Sub-contractors, Sub-consultants, Service providers, Suppliers, Agents personnel, permit the PPRA or any other appropriate authority appointed by Government of Kenya to inspect² all accounts, records and other documents relating to the procurement process, selection and/or contract execution, and to have them audited by auditors appointed by the PPRA or any other appropriate authority appointed by Government of Kenya; and
 - f) Pursuant to Section 62 of the above Act, requires Applicants/Tenderers to submit along with their Applications/Tenders/Proposals a “Self-Declaration Form” as included in the procurement document declaring that they and all parties involved in the procurement process and contract execution have not engaged/will not engage in any corrupt or fraudulent practices.

¹For the avoidance of doubt, a party's ineligibility to be awarded a contract shall include, without limitation, (i) applying for pre-qualification, expressing interest in a consultancy, and tendering, either directly or as a nominated sub-contractor, nominated consultant, nominated manufacturer or supplier, or nominated service provider, in respect of such contract, and (ii) entering into an addendum or amendment introducing a material modification to any existing contract.

² Inspections in this context usually are investigative (i.e., forensic) in nature. They involve fact-finding activities undertaken by the Investigating Authority or persons appointed by the Procuring Entity to address specific matters related to investigations/audits, such as evaluating the veracity of an allegation of possible Fraud and Corruption, through the appropriate mechanisms. Such activity includes but is not limited to: accessing and examining a firm's or individual's financial records and information, and making copies thereof as relevant; accessing and examining any other documents, data and information (whether in hard copy or electronic format) deemed relevant for the investigation/audit, and making copies thereof as relevant; interviewing staff and other relevant individuals; performing physical inspections and site visits; and obtaining third party verification of information.

TENDERER INFORMATION FORM

[The tenderer shall fill in this Form in accordance with the instructions indicated below. No alterations to its format shall be permitted and no substitutions shall be accepted.]

Date: *[insert date (as day, month and year) of Tender submission]*

Tender Name and Identification: *[Insert identification]*

Alternative No.: *[insert identification No if this is a Tender for an alternative]*

Page_of____pages

1. Tenderer's Name <i>[insert Tenderer's legal name]</i>
2. In case of JV, legal name of each member: <i>[insert legal name of each member in JV]</i>
3. Tenderer's actual or intended country of registration: <i>[insert actual or intended country of registration]</i>
4. Tenderer's year of registration: <i>[insert Tenderer's year of registration]</i>
5. Tenderer's Address in country of registration: <i>[insert Tenderer's legal address in country of registration]</i>
6. Tenderer's Authorized Representative Information Name: <i>[insert Authorized Representative's name]</i> Address: <i>[insert Authorized Representative's Address]</i> Telephone/Fax numbers: <i>[insert Authorized Representative's telephone/fax numbers]</i> Email Address: <i>[insert Authorized Representative's email address]</i>
7. Attached are copies of original documents of <i>[check the box(es) of the attached original documents]</i> <input type="checkbox"/> For Kenyan Tenderers a current tax clearance certificate or tax exemption certificate issued by the Kenya Revenue Authority in accordance with ITT 3.14. <input type="checkbox"/> Articles of Incorporation (or equivalent documents of constitution or association), and/or documents of registration of the legal entity named above, in accordance with ITT 3.4. <input type="checkbox"/> In case of JV, letter of intent to form JV or JV agreement, in accordance with ITT 3.1. <input type="checkbox"/> In case of state-owned enterprise or institution, in accordance with ITT 4.6 documents establishing: (i) Legal and financial autonomy (ii) Operation under commercial law (iii) Establishing that the tenderer is not under the supervision of the Procuring Entity 2. Included are the organizational chart, a list of Board of Directors, and the beneficial ownership.

TENDERER’S ELIGIBILITY- CONFIDENTIAL BUSINESS QUESTIONNAIRE FORM

a) Instruction to Tenderer

Tender is instructed to complete the particulars required in this Form, *one form for each entity if Tender is a JV*. Tenderer is further reminded that it is an offence to give false information on this Form.

A. Tenderer’s details

	ITEM	DESCRIPTION
1	Name of the Procuring Entity	
2	Name of the Tenderer	
3	Full Address and Contact Details of the Tenderer.	1. Country 2. City 3. Location 4. Building 5. Floor 6. Postal Address 7. Name and email of contact person.
4	Reference Number of the Tender	
5	Date and Time of Tender Opening	
6	Current Trade License No and Expiring date	
7	Maximum value of business which the Tenderer handles.	
8		

General and Specific Details

b) Sole Proprietor, provide the following details.

Name in full _____

Age _____

Nationality _____

Country of Origin _____

Citizenship _____

c) Partnership, provide the following details.

	Names of Partners	Nationality	Citizenship	% Shares owned
1				
2				
3				

(d) Registered Company, provide the following details.

i) Private or public Company _____

ii) State the nominal and issued capital of the Company-

Nominal Kenya Shillings (Equivalent)

Issued Kenya Shillings (Equivalent)

iii) Give details of Directors as follows.

	Names of Director	Nationality	Citizenship	% Shares owned
1				
2				
3				

(e) DISCLOSURE OF INTEREST- Interest of the Firm in the Procuring Entity.

(i) Are there any person/persons in (Name of Procuring Entity) who has an interest or relationship in this firm? Yes/No.....

If yes, provide details as follows.

	Names of Person	Designation in the Procuring Entity	Interest or Relationship with Tenderer
1			
2			
3			

(ii) Conflict of interest disclosure

	Type of Conflict	Disclosure YES OR NO	If YES provide details of the relationship with Tenderer
1	Tenderer is directly or indirectly controlled by or is under common control with another tenderer.		
2	Tenderer receives or has received any direct or indirect subsidy from another tenderer.		
3	Tenderer has the same legal representative as another tenderer		
4	Tender has a relationship with another tenderer, directly or through common third parties that puts it in a position to influence the tender of another tenderer, or influence the decisions of the Procuring Entity regarding this tendering process.		
5	Any of the Tenderer's affiliates participated as a consultant in the preparation of the design or technical specifications of the works		

	Type of Conflict	Disclosure YES OR NO	If YES provide details of the relationship with Tenderer
	that are the subject of the tender.		
6	Tenderer would be providing goods, works, non-consulting services or consulting services during implementation of the contract specified in this Tender Document.		
7	Tenderer has a close business or family relationship with a professional staff of the Procuring Entity who are directly or indirectly involved in the preparation of the Tender document or specifications of the Contract, and/or the Tender evaluation process of such contract.		
8	Tenderer has a close business or family relationship with a professional staff of the Procuring Entity who would be involved in the implementation or supervision of the Contract.		
9	Has the conflict stemming from such relationship stated in item 7 and 8 above been resolved in a manner acceptable to the Procuring Entity throughout the tendering process and execution of the Contract?		

(f) Certification

On behalf of the Tenderer, I certify that the information given above is correct.

Full Name _____

Title or Designation _____

(Signature)

(Date)

TENDERER'S JV MEMBERS INFORMATION FORM

[The tenderer shall fill in this Form in accordance with the instructions indicated below. The following table shall be filled in for the tenderer and for each member of a Joint Venture]].

Date:.....*[insert date (as day, month and year) of Tender submission]*.

Tender Name and Identification:.....*[insert identification]*

Alternative No.:.....*[insert identification No if this is a Tender for an alternative]*.

Page _____ of _____ pages

1. Tenderer's Name: <i>[insert Tenderer's legal name]</i>
2. Tenderer's JV Member's name: <i>[insert JV's Member legal name]</i>
3. Tenderer's JV Member's country of registration: <i>[insert JV's Member country of registration]</i>
4. Tenderer's JV Member's year of registration: <i>[insert JV's Member year of registration]</i>
5. Tenderer's JV Member's legal address in country of registration: <i>[insert JV's Member legal address in country of registration]</i>
6. Tenderer's JV Member's authorized representative information Name: <i>[insert name of JV's Member authorized representative]</i> Address: <i>[insert address of JV's Member authorized representative]</i> Telephone/Fax numbers: <i>[insert telephone/fax numbers of JV's Member authorized representative]</i> Email Address: <i>[insert email address of JV's Member authorized representative]</i>
7. Attached are copies of original documents of <i>[check the box(es) of the attached original documents]</i> <input type="checkbox"/> Articles of Incorporation (or equivalent documents of constitution or association), and/or registration documents of the legal entity named above, in accordance with ITT 4.4. <input type="checkbox"/> In case of a state-owned enterprise or institution, documents establishing legal and financial autonomy, operation in accordance with commercial law, and that they are not under the supervision of the Procuring Entity, in accordance with ITT 4.6.
8. Included are the organizational chart, a list of Board of Directors, and the beneficial ownership.

RICE SCHEDULE FORMS

[The tenderer shall fill in these Price Schedule Forms in accordance with the instructions indicated. The list of line items in column 1 of the Price Schedules shall coincide with the List of Goods and Related Services specified by the Procuring Entity in the Schedule of Requirements.]

PRICE AND SCHEDULE OF REQUIREMENTS

PRICE SCHEDULE

Item	Description	UoM	Qty	Unit price	Total price
<u>1.</u>	Hydraulic Jack for Cylinder head: Type Hollow plunger Cylinder HC6006T or equivalent. with saddle	PC	2		
<u>2.</u>	Air Operated Hydraulic Pump Type: Power Team SPX Hydraulic Standard Power Pack HPuTP150001 or equivalent	PC	1		
<u>3.</u>	Hydraulic Puller 2 Leg Type: AP1205 or equivalent	PC	1		
<u>4.</u>	Hydraulic Puller 3 Leg Type: AP1305 or equivalent	PC	1		
<u>5.</u>	Hydraulic Set APH0503 or equivalent	PC	1		
<u>6.</u>	Hydraulic accumulators universal charging and testing unit fpu-1 or equivalent complete with accessories	PC	2		
<u>7.</u>	Nitrogen gas Cylinder, complete with Nitrogen Gas	PC	5		
				Total Cost	
				Discount (%) if any	
				VAT 16%	
				Total Cost (DDP)to Kipevu III store	
				Currency of tender	
				Delivery Period	

BIDDERS'S NAME: _____

BIDDER'S SIGNATURE: _____

COMPANY'S RUBBER STAMP: _____

DATE: _____

FORM OF TENDER SECURITY- [Option 1–Demand Bank Guarantee]

Beneficiary:_____

Request for Tenders No:_____

Date:_____

TENDER GUARANTEE No.:_____

Guarantor: _____

1. We have been informed that _____ (here in after called "the Applicant") has submitted or will submit to the Beneficiary its Tender (here in after called" the Tender") for the execution of _____ under Request for Tenders No. _____ ("the ITT").
2. Furthermore, we understand that, according to the Beneficiary's conditions, Tenders must be supported by a Tender guarantee.
3. At the request of the Applicant, we, as Guarantor, hereby irrevocably undertake to pay the Beneficiary any sum or sums not exceeding in total an amount of _____ upon receipt by us of the Beneficiary's complying demand, supported by the Beneficiary's statement, whether in the demand itself or a separate signed document accompanying or identifying the demand, stating that either the Applicant:
 - (a) has withdrawn its Tender during the period of Tender validity set forth in the Applicant's Letter of Tender ("the Tender Validity Period"), or any extension thereto provided by the Applicant; or
 - b) having been notified of the acceptance of its Tender by the Beneficiary during the Tender Validity Period or any extension there to provided by the Applicant, (i) has failed to execute the contract agreement, or (ii) has failed to furnish the Performance.
4. This guarantee will expire: (a) if the Applicant is the successful Tenderer, upon our receipt of copies of the contract agreement signed by the Applicant and the Performance Security and, or (b) if the Applicant is not the successful Tenderer, upon the earlier of (i) our receipt of a copy of the Beneficiary's notification to the Applicant of the results of the Tendering process; or (ii) thirty days after the end of the Tender Validity Period.
5. Consequently, any demand for payment under this guarantee must be received by us at the office indicated above on or before that date.

[signature(s)]

FORM OF TENDER SECURITY (TENDER BOND)

[The Surety shall fill in this Tender Bond Form in accordance with the instructions indicated.]

BOND NO. _____

1. BY THIS BOND.....[name of tenderer] as Principal (hereinafter called —the Principal), and..... [name, legal title, and address of surety], authorized to transact business in [name of country of Procuring Entity], as Surety (hereinafter called —the Surety), are held and firmly bound unto..... [name of Procuring Entity] as Obligee (hereinafter called —the Procuring Entity) in the sum of.....[amount of Bond]¹[amount in words], for the payment of which sum, well and truly to be made, we, the said Principal and Surety, bind ourselves, our successors and assigns, jointly and severally, firmly by these presents.
2. WHEREAS the Principal has submitted or will submit a written Tender to the Procuring Entity dated the _____ day of _____, 20_____, for the supply of _____ [name of Contract] (hereinafter called the —Tender).
3. NOW, THEREFORE, THE CONDITION OF THIS OBLIGATION is such that if the Principal:
 - a) has withdrawn its Tender during the period of Tender validity set forth in the Principal's Letter of Tender (—the Tender Validity Period), or any extension thereto provided by the Principal; or
 - b) having been notified of the acceptance of its Tender by the Procuring Entity during the Tender Validity Period or any extension thereto provided by the Principal;
 - (i) failed to execute the Contract agreement; or
 - (ii) has failed to furnish the Performance Security, in accordance with the Instructions to tenderers (—ITT) of the Procuring Entity's Tendering document.

then the Surety undertakes to immediately pay to the Procuring Entity up to the above amount upon receipt of the Procuring Entity's first written demand, without the Procuring Entity having to substantiate its demand, provided that in its demand the Procuring Entity shall state that the demand arises from the occurrence of any of the above events, specifying which event(s) has occurred.
4. The Surety hereby agrees that its obligation will remain in full force and effect up to and including the date 30 days after the date of expiration of the Tender Validity Period set forth in the Principal's Letter of Tender or any extension thereto provided by the Principal.
5. IN TESTIMONY WHEREOF, the Principal and the Surety have caused these presents to be executed in their respective names this _____ day of _____ 20_____.

Principal:___ Corporate Seal (where appropriate) Surety: _____

(Signature)

(Printed name and title)

and title

(Signature)

(Printed name

¹The amount of the Bond shall be denominated in the currency Kenya shillings or the equivalent amount in a freely convertible currency.

FORM OF TENDER-SECURING DECLARATION

[The Bidder shall complete this Form in accordance with the instructions indicated]

Date:.....[insert date (as day, month and year) of Tender Submission]

Tender No.:.....[insert number of tendering process]

To:.....[insert complete name of Purchaser]

I/We, the undersigned, declare that:

1. I/We understand that, according to your conditions, bids must be supported by a Tender-Securing Declaration.
2. I/We accept that I/we will automatically be suspended from being eligible for tendering in any contract with the Purchaser for the period of time of[**2 years**] starting on[**date of tender submission**], if we are in breach of our obligation(s) under the bid conditions, because we – (a) have withdrawn our tender during the period of tender validity specified by us in the Tendering Data Sheet; or (b) having been notified of the acceptance of our Bid by the Purchaser during the period of bid validity, (i) fail or refuse to execute the Contract, if required, or (ii) fail or refuse to furnish the Performance Security, in accordance with the instructions to tenders.
3. I/We understand that this Tender Securing Declaration shall expire if we are not the successful Tenderer(s), upon the earlier of:
 - a) our receipt of a copy of your notification of the name of the successful Tenderer; or
 - b) thirty days after the expiration of our Tender.
4. I/We understand that if I am/we are/in a Joint Venture, the Tender Securing Declaration must be in the name of the Joint Venture that submits the bid, and the Joint Venture has not been legally constituted at the time of bidding, the Tender Securing Declaration shall be in the names of all future partners as named in the letter of intent.

Signed:.....

Capacity / title (director or partner or sole proprietor, etc.)

Name:.....

Duly authorized to sign the bid for and on behalf of:[insert complete name of Tenderer].

Dated on day of [Insert date of signing].

Seal or stamp.

MANUFACTURER'S AUTHORIZATION FORM

[The tenderer shall require the Manufacturer to fill in this Form in accordance with the instructions indicated. This letter of authorization should be on the letterhead of the Manufacturer and should be signed by a person with the proper authority to sign documents that are binding on the Manufacturer. The tenderer shall include it in its Tender, if so indicated in the TDS.]

Date:.....*[insert date (as day, month and year) of Tender submission]*

ITT No.:.....*[insert number of ITT process]*

Alternative No.:.....*[insert identification No if this is a Tender for an alternative]*

To: *[Insert complete name of Procuring Entity]*

WHEREAS

We..... *[insert complete name of Manufacturer]*, who are official manufacturers of.....*[insert type of goods manufactured]*, having factories at *[insert full address of Manufacturer's factories]*, do hereby authorize *[insert complete name of tenderer]* to submit a Tender the purpose of which is to provide the following Goods, manufactured by us.....*[insert name and or brief description of the Goods]*, and to subsequently negotiate and sign the Contract.

We hereby extend our full guarantee and warranty in accordance with Clause 28 of the General Conditions of Contract, with respect to the Goods offered by the above firm.

Signed:..... *[Insert signature(s) of authorized representative(s) of the Manufacturer]*

Name:.....*[Insert complete name(s) of authorized representative(s) of the Manufacturer]*

Title:..... *[Insert title]*

Dated on _____ day of _____, _____ *[insert date of signing]*

PART 2: SUPPLY REQUIREMENTS

SECTION V - SCHEDULE OF REQUIREMENTS

General

These specifications describe the requirements for goods. Tenderers are requested to submit with their offers the detailed specifications, drawings, catalogues, and other supporting documents etc. for the products they intend to supply.

Tenderers must indicate on the specifications sheets whether the equipment offered complies with each specified requirement.

TECHNICAL SPECIFICATIONS

All the dimensions and capacities of the equipment to be supplied shall not be less than those required in these specifications. Deviations from the basic requirements, if any shall be explained in detail in writing with the offer, with supporting data such as calculation sheets, etc. KenGen reserves the right to reject the products if such deviations shall be found critical to the use and operation of the products.

The tenderers are requested to present information along with their offers as follows:

Shortest possible delivery period of each product

Information on proper representative and/or workshop for back-up service/repair and maintenance including their names and address.

Inspections and Tests

The following inspections and tests shall be performed: [insert list of inspections and tests]

PARTICULARS

The Power Plant is Kipevu III Diesel Power Plant owned by The Kenya Electricity Generating Company PLC (KenGen).

TENDER FOR SUPPLY OF HYDRAULIC EQUIPMENT FOR KIPEVU III DIESEL PLANT

Introduction:

KenGen operates Diesel Power Plant at Kipevu III in Mombasa, Kenya.

KenGen operates Diesel Power Plant at Kipevu III, Mombasa, Kenya producing a total of 115 MW. The power plant includes engines, generators and the auxiliary equipment needed for power production. The equipment at the power plant is always maintained during different plant maintenance schedules and effective tools are always required to ensure maintenance is done effectively and efficiently.

The plant seeks to procure the special tools to enhance efficient equipment and engine overhauls and reduce wrench time. This will enable the plant to have always high plant availability.

Technical Specifications

(A.) Hydraulic Jack for Cylinder head:

Type Hollow plunger Cylinder HC6006T or equivalent with saddle

HOLLOW HOLE CYLINDER HC6006T 60 TON 6 STROKE 10,000 PSI (700BAR)

Model	HC6006T
Material	Steel
Capacity	60 ton
Oil usage (push)	1282.29 cc
Collapse height	324.1 mm
Extended height	476.5 mm
Effective area (push)	84.19 cm ²
Intpressure at capacity	633.97 bar
Cylinder bore	103.63 mm
Outside Dia.	158.75 mm
Mounting thread	½"~13UNC in
Internal Thread Length	19.05 mm
Internal Dia. Mounting	54.1 mm
Outside Dia. Mounting	92.96 mm



(B) Air Operated Hydraulic Pump

Type: SPX Hydraulic Standard Power Pack HPuTP150001 or equivalent



Typical uses: Topping bolt tensioners, nutsplitters, hydraulic nuts

- 1500 bar (21,750 psi) max working pressure (restricted)
- Calibrated 150mm (6") Pressure gauge
- Flow Rate up to 0.72 litres/min (44 cu.in/mm)
- Dual oil outlets with quick-connect no spill couplings
- Pneumatic Filter/Regulator/Lubricator
- Air Consumption 800 litres/min (28cfm)
- 9.5 Litre (2 Gal.) polyethylene reservoir
- Stainless Steel carrying frame
- Size (WxLxH) - 410 x 470 x 410 (mm)
- Approx weight: 19 Kg



(C) Hydraulic Puller 2 Leg

Type: AP1205 or equivalent

- Pullers for Single Acting Cylinders.

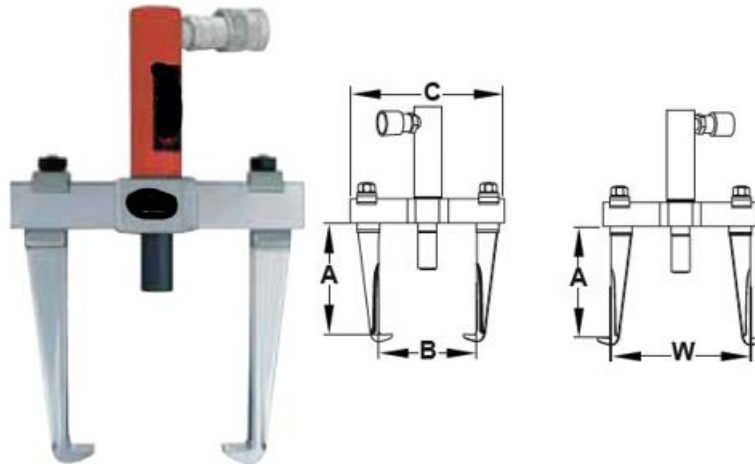

Model Number	Cylinder (Optional)	Capacity (Tonne)	A (mm)	B Min. (mm)	B Max. (mm)	W (mm)	W (mm)	C (mm)	Weight (kg)
AP1205	H0503	5	160	60	200	175	270	260	8.5

Hydraulic Puller 3 Leg

Type: AP1305 or equivalent

- Pullers for Single Acting Cylinders.

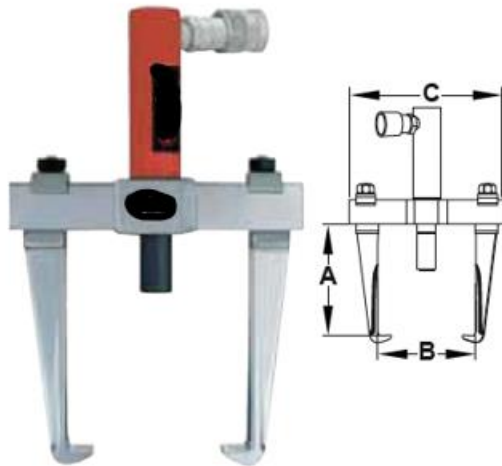

Model Number	Cylinder (Optional)	Capacity (Ton)	A (mm)	B Max. (mm)
AP1305	H0503	5	225	240

Puller Kit

(Excluding Cylinder)

Content:

- 2/3 Leg Puller
- 2 Leg Puller
- Extensions for 2 Leg Puller
- Splitter

(D) Hydraulic Set APH0503 or equivalent

Hydraulic Set - Single Acting Cylinder

Content:

- Handpump P350
- Cylinder H0503
- Gauge and Gauge adapter
- Adapter
- Hose
- Fitting and Coupler



Hydraulic Set	Capacity (Tonne)	Handpump	Fitting	Gauge + Adapter	Hose	Coupler	Cylinder	Weight (kg)
APH0503	5	P350	CA3814	GBW1460 + CF3814	CS3814-2	CH38-M	H0503	8

UNIVERSAL CHARGING AND TESTING UNIT FPU-1 and NITROGEN GAS CYLINDERS

MODEL CODE: FPU-1 25 F 4 G2 A3 or Equivalent

Item No.	Item	Description
1.	Gauge indication range	25 Bar
2.	Charging hose	for 200 bar nitrogen bottle with connection W24.32x1/14 (DIN 477)
3.	Length of charging hose	4M
4.	Adaptor G for nitrogen bottles	G2 (236376) for Kenya
5.	Adaptor A	A3 = 7/8 - 14 UNF
6.	Protective case	Industrial grade Plastic Case padded with foam
7.	Accessories	-Pressure Gauge 0-10 bar -Pressure Gauge 0-6 Bar -Gas safety valve with intermediate piece -Pressure reducer Adaptor for connector D -Wrench 14x15 -Allen key SW6 -Valve tool for gas valve -Torque wrench 2.26-22.6 Nm Industrial grade. - Aluminium-Titanium Alloy handle, wrench head equipped with a release button.

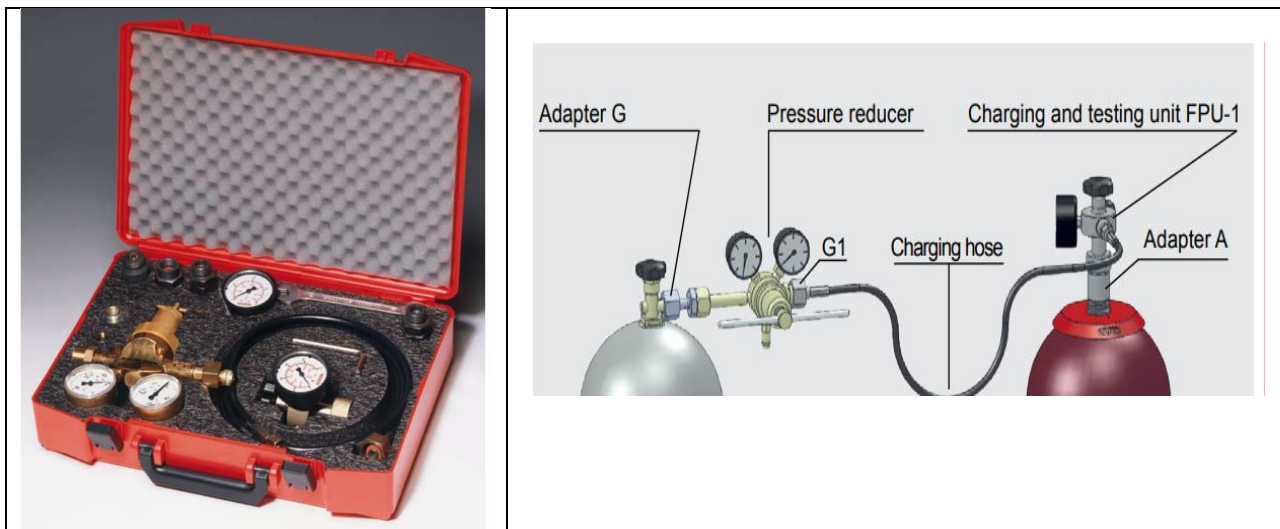

Training

- i. Maintenance: the contractor shall conduct a site training for the maintenance team Ten (10) on the operation and maintenance of the hydraulic equipment.
- ii. The contractor to provide necessary training materials.
- iii. The contractor to provide necessary training materials.
- iv. Duration: The site training shall be for at least Five (5) days

Acknowledgement of Specifications

We _____ as per the KenGen specifications outlined above do hereby confirm that we shall deliver.

Signed _____

Stamp _____

PART 3 –CONDITIONS OF CONTRACT AND CONTRACT FORMS

SECTION VI - GENERAL CONDITIONS OF CONTRACT

1. Definitions

In the Conditions of Contract (“these Conditions”), which include Special Conditions, Parts A and B, and these General Conditions, the following words and expressions shall have the meanings stated. Words indicating persons or parties include corporations and other legal entities, except where the context requires otherwise.

- a) “Contract” means the Contract Agreement entered into between the Procuring Entity and the Supplier, together with the Contract Documents referred to therein, including all attachments, appendices, and all documents incorporated by reference therein.
- b) “Contract Documents” means the documents listed in the Contract Agreement, including any amendments thereto.
- c) “Contract Price” means the price payable to the Supplier as specified in the Contract Agreement, subject to such additions and adjustments thereto or deductions therefrom, as may be made pursuant to the Contract.
- d) “Day” means calendar day.
- e) “Completion” means the fulfilment of the Related Services by the Supplier in accordance with the terms and conditions set forth in the Contract.
- f) “GCC” means the General Conditions of Contract.
- g) “Goods” means all of the commodities, raw material, machinery and equipment, and/or other materials that the Supplier is required to supply to the Procuring Entity under the Contract.
- h) “Procuring Entity” means the Procuring Entity purchasing the Goods and Related Services, as **specified in the SCC**.
- i) “Related Services” means the services incidental to the supply of the goods, such as insurance, delivery, installation, commissioning, training and initial maintenance and other such obligations of the Supplier under the Contract.
- j) “SCC” means the Special Conditions of Contract.
- k) “Subcontractor” means any person, private or government entity, or a combination of the above, to whom any part of the Goods to be supplied or execution of any part of the Related Services is subcontracted by the Supplier.
- l) “Supplier” means the person, private or government entity, or a combination of the above, whose Tender to perform the Contract has been accepted by the Procuring Entity and is named as such in the Contract Agreement.
- m) “**Base Date**” means a date 30 day prior to the submission of tenders.
- n) “**Laws**” means all national legislation, statutes, ordinances, and regulations and by-laws of any legally constituted public authority.
- o) “**Letter of Acceptance**” means the letter of formal acceptance, signed by the contractor. Procuring Entity, including any annexed memoranda comprising agreements between and signed by both Parties.
- p) “**Procuring Entity**” means the Entity named in the Special Conditions of Contract.

2. Interpretation

- 2.1. If the context so requires it, singular means plural and vice versa.

22. Incoterms

- a) Unless inconsistent with any provision of the Contract, the meaning of any trade term and the rights and obligations of parties thereunder shall be as prescribed by Incoterms **specified in the SCC**.
- b) The terms EXW and CIP and other similar terms, when used, shall be governed by the rules prescribed in the current edition of Incoterms specified in the **SCC** and published by the International Chamber of Commerce in Paris, France.

3. Contract Documents

Subject to the order of precedence set forth in the Contract Agreement, all documents forming the Contract (and all parts thereof) are intended to be correlative, complementary, and mutually explanatory. The Contract Agreement shall be read as a whole. The documents forming the Contract shall be interpreted in the following order of priority:

- a) the Contract Agreement,
- b) the Letter of Acceptance,
- c) the General Conditions of Contract
- d) Special Conditions of Contract
- e) the Form of Tender,
- f) the Specifications and Schedules of the Drawings (if any), and
- g) the Schedules of Requirements, Price Schedule and any other documents forming part of the Contract.

4. Fraud and Corruption

- 3.1 The supplier shall comply with anti-corruption laws and guidelines and the prevailing sanctions, policies and procedures as set forth in the Laws of Kenya.
- 3.2 The Supplier shall disclose any commissions, gratuity or fees that may have been paid or are to be paid to agents or any other person with respect to the Tendering process or execution of the Contract. The information disclosed must include at least the name and address of the agent or other party, the amount and currency, and the purpose of the commission, gratuity or fee.

45 4.1 Entire Agreement

- 4.3.1 The Contract constitutes the entire agreement between the Procuring Entity and the Supplier and supersedes all communications, negotiations and agreements (whether written or oral) of the parties with respect thereto made prior to the date of Contract.

4.2 Amendment

No amendment or other variation of the Contract shall be valid unless it is in writing, is dated, expressly refers to the Contract, and is signed by a duly authorized representative of each party thereto.

4.3 Non-waiver

- a) Subject to GCC Sub-Clause 4.5(b) below, no relaxation, forbearance, delay, or indulgence by either party in enforcing any of the terms and conditions of the Contract or the granting of time by either party to the other shall prejudice, affect, or restrict the rights of that party under the Contract, neither shall any waiver by either party of any breach of Contract operate as waiver of any subsequent or continuing breach of Contract.
- b) Any waiver of a party's rights, powers, or remedies under the Contract must be in writing, dated, and signed by an authorized representative of the party granting such waiver, and must specify the right and the extent to which it is being waived.

4.4 Severability

If any provision or condition of the Contract is prohibited or rendered invalid or unenforceable, such prohibition, invalidity or unenforceability shall not affect the validity or enforceability of any other provisions and conditions of the Contract.

5. Language

5.1 The Contract as well as all correspondence and documents relating to the Contract exchanged by the Supplier and the Procuring Entity, shall be written in the **English Language**. Supporting documents and printed literature that are part of the Contract may be in another language provided they are accompanied by an accurate and certified translation of the relevant passages in the **English Language**, in which case, for purposes of interpretation of the Contract, the English language is translation shall govern.

5.2 The Supplier shall bear all costs of translation to the governing language and all risks of the accuracy of such translation, for documents provided by the Supplier.

6. Joint Venture, Consortium or Association

6.1 If the Supplier is a joint venture, consortium, or association, all of the parties shall be jointly and severally liable to the Procuring Entity for the fulfilment of the provisions of the Contract and shall designate one member of the joint venture, consortium, or association to act as a leader with authority to bind the joint venture, consortium, or association. The composition or the constitution of the joint venture, consortium, or association shall not be altered without the prior written consent of the Procuring Entity.

7. Eligibility

7.1 The Supplier and its Subcontractors shall have the nationality of an eligible country. A Supplier or Sub-contractor shall be deemed to have the nationality of a country if it is a citizen or constituted, incorporated, or registered, and operates in conformity with the provisions of the laws of that country.

7.2 All Goods and Related Services to be supplied under the Contract shall have their origin in Eligible Countries. For the purpose of this Clause, origin means the country where the goods have been grown, mined, cultivated, produced, manufactured, or processed; or through manufacture, processing, or assembly, another commercially recognized article results that differs substantially in its basic characteristics from its components.

7.3 The Tenderer, if a Kenyan firm, must submit with its tender a valid tax compliance certificate from the Kenya Revenue Authority.

8. Notices

8.1 Any notice given by one party to the other pursuant to the Contract shall be in writing to the address specified in the **SCC**. The term "in writing" means communicated in written form with proof of receipt.

8.2 A notice shall be effective when delivered or on the notice's effective date, whichever is later.

9. Governing Law

9.1 The Contract shall be governed by and interpreted in accordance with the laws of Kenya.

9.2 Throughout the execution of the Contract, the Supplier shall comply with the import of goods and services prohibitions in Kenya:

- a) where, as a matter of law, compliance or official regulations, Kenya prohibits commercial relations with that country or any import of goods from that country or any payments to any country, person, or entity in that country ; or
- b) by an act of compliance with a decision of the United Nations Security Council taken under Chapter VII of the Charter of the United Nations, Kenya prohibits any import of goods from that country or any payments to any country, person, or entity.

10. Settlement of Disputes

- 10.1 The Procuring Entity and the Supplier shall make every effort to resolve amicably by direct negotiation any disagreement or dispute arising between them under or in connection with the Contract.
- 10.2 If, after thirty (30) days, the parties have failed to resolve their dispute or difference by such mutual consultation, then either the Procuring Entity or the Supplier may give notice to the other party of its intention to commence arbitration, as hereinafter provided, as to the matter in dispute, and no arbitration in respect of this matter may be commenced unless such notice is given. Any dispute or difference in respect of which a notice of intention to commence arbitration has been given in accordance with this Clause shall be finally settled by arbitration. Arbitration may be commenced prior to or after delivery of the Goods under the Contract.
- 10.2 Arbitration proceedings shall be conducted as follows:**
- 10.2.1 Any claim or dispute between the Parties arising out of or in connection with the Contract not settled amicably in accordance with Sub-Clause 10.1 shall be finally settled by arbitration.
- 10.2.2 No arbitration proceedings shall be commenced on any claim or dispute where notice of a claim or dispute has not been given by the applying party within thirty days of the occurrence or discovery of the matter or issue giving rise to the dispute.
- 10.2.3 Notwithstanding the issue of a notice as stated above, the arbitration of such a claim or dispute shall not commence unless an attempt has in the first instance been made by the parties to settle such claim or dispute amicably with or without the assistance of third parties. Proof of such attempt shall be required.
- 10.2.4 The Arbitrator shall, without prejudice to the generality of his powers, have powers to direct such measurements, computations, or valuations as may in his opinion be desirable in order to determine the rights of the parties and assess and award any sums which ought to have been the subject of or included in any due payments.
- 10.2.5 Neither Party shall be limited in the proceedings before the arbitrators to the evidence, or to the reasons for the dispute given in its notice of a claim or dispute.
- 10.2.6 Arbitration may be commenced prior to or after delivery of the goods. The obligations of the Parties shall not be altered by reason of any arbitration being conducted during the progress of the delivery of goods.
- 10.2.7 The terms of the remuneration of each or all the members of Arbitration shall be mutually agreed upon by the Parties when agreeing the terms of appointment. Each Party shall be responsible for paying one-half of this remuneration.

10.3 Arbitration Proceedings

- 10.3.1 Arbitration proceedings with national suppliers will be conducted in accordance with the Arbitration Laws of Kenya. In case of any claim or dispute, such claim or dispute shall be notified in writing by either party to the other with a request to submit it to arbitration and to concur in the appointment of an Arbitrator within thirty days of the notice. The dispute shall be referred to the arbitration and final decision of a person or persons to be agreed between the parties. Failing agreement to concur in the appointment of an Arbitrator, the Arbitrator shall be appointed, on the request of the applying party, by the Chairman or Vice Chairman of any of the following professional institutions;
- i) Kenya National Chamber of Commerce
 - ii) Chartered Institute of Arbitrators (Kenya Branch)
 - iii) The Law Society of Kenya
- 10.3.2 The institution written to first by the aggrieved party shall take precedence over all other institutions.

10.3.3 Alternative Arbitration Proceedings

Alternatively, the Parties may refer the matter to the Nairobi Centre for International

Arbitration (NCIA) which offers a neutral venue for the conduct of national and international arbitration with commitment to providing institutional support to the arbitral process.

104 Arbitration with Foreign Suppliers

104.1 Arbitration with foreign suppliers shall be conducted in accordance with the arbitration rules of the United Nations Commission on International Trade Law (UNCITRAL); or with proceedings administered by the International Chamber of Commerce (ICC) and conducted under the ICC Rules of Arbitration; by one or more arbitrators appointed in accordance with said arbitration rules.

104.2 The place of arbitration shall be a location specified in the **SCC**; and the arbitration shall be conducted in the language for communications defined in Sub-Clause 1.4 [Law and Language].

105 Alternative Arbitration Proceedings

Alternatively, the Parties may refer the matter to the Nairobi Centre for International Arbitration (NCIA) which offers a neutral venue for the conduct of national and international arbitration with commitment to providing institutional support to the arbitral process.

106 Failure to Comply with Arbitrator's Decision

106.1 The award of such Arbitrator shall be final and binding upon the parties.

10.6.1 In the event that a Party fails to comply with a final and binding Arbitrator's decision, then the other Party may, without prejudice to any other rights it may have, refer the matter to a competent court of law.

107 Contract operations continue

Notwithstanding any reference to arbitration herein,

- a) the parties shall continue to perform their respective obligations under the Contract unless they otherwise agree; and
- b) the Procuring Entity shall pay the Supplier any monies due the Supplier.

11. Inspections and Audit by the Procuring Entity

11.1 The Supplier shall keep, and shall cause its Subcontractors to keep, accurate and systematic accounts and records in respect of the Goods in such form and details as will clearly identify relevant time, changes and costs.

11.2 Pursuant to paragraph 2.2 of Instruction to Tenderers, the Supplier shall permit and shall cause its subcontractors to permit, the Procuring Entity and/or persons appointed by the Procuring Entity or by other statutory bodies of the Government to inspect the Site and/or the accounts and records relating to the procurement process, selection and/or contract execution, and to have such accounts and records audited by auditors appointed by the Procuring Entity. The Supplier's and its Subcontractors' attention is drawn to Sub- Clause 3.1 which provides, inter alia, that acts intended to materially impede the exercise of the Procuring Entity's inspection and audit rights constitute a prohibited practice subject to contract termination, as well as to a determination of ineligibility.

12. Scope of Supply

12.1 The Goods and Related Services to be supplied shall be as specified in the Schedule of Requirements.

13. Delivery and Documents

13.1 Subject to GCC Sub-Clause 33.1, the delivery of the Goods and completion of the Related

Services shall be in accordance with the List of Goods and Delivery Schedule specified in the Supply Requirements. The details of shipping and other documents to be furnished by the Supplier are specified in the SCC.

14. Supplier's Responsibilities

- 14.1 The Supplier shall supply all the Goods and Related Services included in the Scope of Supply in accordance with GCC Clause 12, and the Delivery and Completion Schedule, as per GCC Clause 13.

15. Contract Price

- 15.1 Prices charged by the Supplier for the Goods supplied and the Related Services performed under the Contract shall not vary from the prices quoted by the Supplier in its Tender, with the exception of any price adjustments authorized in the SCC.

- 15.2 Where the contract price is different from the corrected tender price, in order to ensure the supplier is not paid less or more relative to the contract price (*which would be the tender price*), any partial payment valuation based on rates in the schedule of prices in the Tender, will be adjusted by a plus or minus percentage. The percentage already worked out during tender evaluation is worked out as follows: $(\text{corrected tender price} - \text{tender price}) / \text{tender price} \times 100$.

16. Terms of Payment

- 16.1 The Supplier shall request for payment by submitting invoice(s), delivery note(s) and any other relevant documents as specified in the SCC to the Procuring Entity.
- 16.2 Payments shall be made promptly by the Procuring Entity, but not later than thirty (30) days after submission of an invoice by the Supplier, and after the Procuring Entity has accepted it.
- 16.3 Where a Procuring Entity rejects Goods and Related Services, in part or wholly, the procuring Entity shall promptly inform the Supplier to collect, replace or rectify as appropriate and give reasons for rejection. The Supplier shall submit a fresh invoice, delivery note and any other relevant documents as specified in the SCC.
- 16.4 The currencies in which payments shall be made to the Supplier under this Contract shall be those in which the Tender price is expressed.
- 16.5 In the event that the Procuring Entity fails to pay the Supplier any payment by its due date or within the period set forth in the SCC, the Procuring Entity may pay to the Supplier interest on the amount of such delayed payment at the rate shown in the SCC, for the period of delay until payment has been made in full, whether before or after judgment or arbitrage award.

17. Taxes and Duties

- 17.1 The Supplier shall be entirely responsible for all taxes, duties, license fees, and other such levies incurred to deliver the Goods and Related Services to the Procuring Entity at the final delivery point.
- 17.3 If any tax exemptions, reductions, allowances or privileges may be available to the Supplier in Kenya, the Supplier shall inform the Procuring Entity and the Procuring Entity shall use its best efforts to enable the Supplier to benefit from any such tax savings to the maximum allowable extent.

18. Performance Security

- 18.1 If required as specified in the SCC, the Supplier shall, within twenty-eight (28) days of the notification of contract award, provide a performance security for the performance of the Contract in the amount specified in the SCC.

- 182 The proceeds of the Performance Security shall be payable to the Procuring Entity as compensation for any loss resulting from the Supplier's failure to complete its obligations under the Contract.
- 183 As specified in **the SCC**, the Performance Security, if required, shall be denominated in the currency(ies) of the Contract, or in a freely convertible currency acceptable to the Procuring Entity; and shall be in one of the formats stipulated by the Procuring Entity in **the SCC**, or in another format acceptable to the Procuring Entity.
- 184 The Performance Security shall be discharged by the Procuring Entity and returned to the Supplier not later than thirty (30) days following the date of Completion of the Supplier's performance obligations under the Contract, including any warranty obligations, unless specified otherwise in the **SCC**.

19. Copyright

- 19.1 The copyright in all drawings, documents, and other materials containing data and information furnished to the Procuring Entity by the Supplier herein shall remain vested in the Supplier, or, if they are furnished to the Procuring Entity directly or through the Supplier by any third party, including suppliers of materials, the copyright in such materials shall remain vested in such third party.

20. Confidential Information

- 20.1 The Procuring Entity and the Supplier shall keep confidential and shall not, without the written consent of the other party hereto, divulge to any third party any documents, data, or other information furnished directly or indirectly by the other party hereto in connection with the Contract, whether such information has been furnished prior to, during or following completion or termination of the Contract. Notwithstanding the above, the Supplier may furnish to its Sub-Supplier such documents, data, and other information it receives from the Procuring Entity to the extent required for the Sub Supplier to perform its work under the Contract, in which event the Supplier shall obtain from such Sub Supplier undertaking of confidentiality similar to that imposed on the Supplier under GCC Clause 20.
- 20.2 The Procuring Entity shall not use such documents, data, and other information received from the Supplier for any purposes unrelated to the contract. Similarly, the Supplier shall not use such documents, data, and other information received from the Procuring Entity for any purpose other than the performance of the Contract.
- 20.3 The obligation of a party under GCC Sub-Clauses 20.1 and 20.2 above, however, shall not apply to information that:
- a) the Procuring Entity or Supplier need to share with other arms of Government or other bodies participating in the financing of the Contract; such parties shall be disclosed in **the SCC**;
 - b) now or hereafter enters the public domain through no fault of that party;
 - c) can be proven to have been possessed by that party at the time of disclosure and which was not previously obtained, directly or indirectly, from the other party; or
 - d) otherwise lawfully becomes available to that party from a third party that has no obligation of confidentiality.
- 20.4 The above provisions of GCC Clause 20 shall not in any way modify any undertaking of confidentiality given by either of the parties hereto prior to the date of the Contract in respect of the Supply or any part thereof.
- 20.5 The provisions of GCC Clause 20 shall survive completion or termination, for whatever reason, of the Contract.

21. Subcontracting

21.1 The Supplier shall notify the Procuring Entity in writing of all subcontracts awarded under the Contract if not already specified in the Tender. Such notification, in the original Tender or later shall not relieve the Supplier from any of its obligations, duties, responsibilities, or liability under the Contract.

21.2 Subcontracts shall comply with the provisions of GCC Clauses 3 and 7.

22. Specifications and Standards

22.1 Technical Specifications and Drawings

- a) The Goods and Related Services supplied under this Contract shall conform to the technical specifications and standards mentioned in Section VI, Schedule of Requirements and, when no applicable standard is mentioned, the standard shall be equivalent or superior to the official standards whose application is appropriate to the Goods' country of origin.
- b) The Supplier shall be entitled to disclaim responsibility for any design, data, drawing, specification or other document, or any modification thereof provided or designed by or on behalf of the Procuring Entity, by giving a notice of such disclaimer to the Procuring Entity.
- c) Wherever references are made in the Contract to codes and standards in accordance with which it shall be executed, the edition or the revised version of such codes and standards shall be those specified in the Schedule of Requirements. During Contract execution, any changes in any such codes and standards shall be applied only after approval by the Procuring Entity and shall be treated in accordance with GCC Clause 33.

23. Packing and Documents

23.1 The Supplier shall provide such packing of the Goods as is required to prevent their damage or deterioration during transit to their final destination, as indicated in the Contract. During transit, the packing shall be sufficient to withstand, without limitation, rough handling and exposure to extreme temperatures, salt and precipitation, and open storage. Packing case size and weights shall take into consideration, where appropriate, the remoteness of the goods' final destination and the absence of heavy handling facilities at all points in transit.

23.2 The packing, marking, and documentation within and outside the packages shall comply strictly with such special requirements as shall be expressly provided for in the Contract, including additional requirements, if any, specified **in the SCC**, and in any other instructions ordered by the Procuring Entity.

24. Insurance

24.1 Unless otherwise specified in the **SCC**, the Goods supplied under the Contract shall be fully insured—in a freely convertible currency from an eligible country—against loss or damage incidental to manufacture or acquisition, transportation, storage, and delivery, in accordance with the applicable Incoterms or in the manner specified in the **SCC**.

25. Transportation and Incidental Services

25.1 Unless otherwise specified in the **SCC**, responsibility for arranging transportation of the Goods shall be in accordance with the specified Incoterms.

25.2 The Supplier may be required to provide any or all of the following services, including additional services, if any, specified **in SCC**:

- a) performance or supervision of on-site assembly and/or start-up of the supplied Goods;
- b) furnishing of tools required for assembly and/or maintenance of the supplied Goods;
- c) furnishing of a detailed operations and maintenance manual for each appropriate

unit of the supplied Goods;

- d) performance or supervision or maintenance and/or repair of the supplied Goods, for a period of time agreed by the parties, provided that this service shall not relieve the Supplier of any warranty obligations under this Contract; and
- e) training of the Procuring Entity's personnel, at the Supplier's plant and/or on-site, in assembly, start-up, operation, maintenance, and/or repair of the supplied Goods.

253 Prices charged by the Supplier for incidental services, if not included in the Contract Price for the Goods, shall be agreed upon in advance by the parties and shall not exceed the prevailing rates charged to other parties by the Supplier for similar services

26. Inspections and Tests

26.1 The Supplier shall at its own expense and at no cost to the Procuring Entity carry out all such tests and/or inspections of the Goods and Related Services as are specified in the SCC.

26.2 The inspections and tests may be conducted on the premises of the Supplier or its Subcontractor, at point of delivery, and/or at the Goods' final destination, or in another place in Kenya as specified in the SCC. Subject to GCC Sub-Clause 26.3, if conducted on the premises of the Supplier or its Subcontractor, all reasonable facilities and assistance, including access to drawings and production data, shall be furnished to the inspectors at no charge to the Procuring Entity.

26.3 The Procuring Entity or its designated representative shall be entitled to attend the tests and/or inspections referred to in GCC Sub-Clause 26.2, provided that the Procuring Entity bear all of its own costs and expenses incurred in connection with such attendance including, but not limited to, all travelling and board and lodging expenses.

26.4 Whenever the Supplier is ready to carry out any such test and inspection, it shall give a reasonable advance notice, including the place and time, to the Procuring Entity. The Supplier shall obtain from any relevant third party or manufacturer any necessary permission or consent to enable the Procuring Entity or its designated representative to attend the test and/or inspection.

26.5 The Procuring Entity may require the Supplier to carry out any test and/or inspection not required by the Contract but deemed necessary to verify that the characteristics and performance of the Goods comply with the technical specifications codes and standards under the Contract, provided that the Supplier's reasonable costs and expenses incurred in the carrying out of such test and/or inspection shall be added to the Contract Price. Further, if such test and/or inspection impedes the progress of manufacturing and/or the Supplier's performance of its other obligations under the Contract, due allowance will be made in respect of the Delivery Dates and Completion Dates and the other obligations so affected.

26.6 The Supplier shall provide the Procuring Entity with a report of the results of any such test and/or inspection.

26.7 The Procuring Entity may reject any Goods or any part thereof that fail to pass any test and/or inspection or do not conform to the specifications. The Supplier shall either rectify or replace such rejected Goods or parts thereof or make alterations necessary to meet the specifications at no cost to the Procuring Entity, and shall repeat the test and/or inspection, at no cost to the Procuring Entity, upon giving a notice pursuant to GCC Sub- Clause 26.4.

26.8 The Supplier agrees that neither the execution of a test and/or inspection of the Goods or any part thereof, nor the attendance by the Procuring Entity or its representative, nor the issue of any report pursuant to GCC Sub-Clause 26.6, shall release the Supplier from any warranties or other obligations under the Contract.

27. Liquidated Damages

27.1 Except as provided under GCC Clause 32, if the Supplier fails to deliver any or all of the Goods by the Date(s) of delivery or perform the Related Services within the period specified in the Contract, the Procuring Entity may without prejudice to all its other remedies under the Contract, deduct from the Contract Price, as liquidated damages, a sum equivalent to the percentage specified in the SCC of the delivered price of the delayed Goods or unperformed Services for each week or part thereof of delay until actual delivery or performance, up to a maximum deduction of the percentage specified in those SCC. Once the maximum is reached, the Procuring Entity may terminate the Contract pursuant to GCC Clause 35.

28. Warranty

28.1 The Supplier warrants that all the Goods are new, unused, and of the most recent or current models, and that they incorporate all recent improvements in design and materials, unless provided otherwise in the Contract.

28.2 Subject to GCC Sub-Clause 22.1(b), the Supplier further warrants that the Goods shall be free from defects arising from any act or omission of the Supplier or arising from design, materials, and workmanship, under normal use in the conditions prevailing in the country of final destination.

28.3 Unless otherwise specified in the SCC, the warranty shall remain valid for twelve (12) months after the Goods, or any portion thereof as the case may be, have been delivered to and accepted at the final destination indicated in the SCC, or for eighteen (18) months after the date of shipment from the port or place of loading in the country of origin, whichever period concludes earlier.

28.4 The Procuring Entity shall give notice to the Supplier stating the nature of any such defects together with all available evidence thereof, promptly following the discovery thereof. The Procuring Entity shall afford all reasonable opportunity for the Supplier to inspect such defects.

28.5 Upon receipt of such notice, the Supplier shall, within the period specified in the SCC, expeditiously repair or replace the defective Goods or parts thereof, at no cost to the Procuring Entity.

28.6 If having been notified, the Supplier fails to remedy the defect within the period specified in the SCC, the Procuring Entity may proceed to take within a reasonable period such remedial action as may be necessary, at the Supplier's risk and expense and without prejudice to any other rights which the Procuring Entity may have against the Supplier under the Contract.

29. Patent Indemnity

29.1 The Supplier shall, subject to the Procuring Entity's compliance with GCC Sub-Clause 29.2, indemnify and hold harmless the Procuring Entity and its employees and officers from and against any and all suits, actions or administrative proceedings, claims, demands, losses, damages, costs, and expenses of any nature, including attorney's fees and expenses, which the Procuring Entity may suffer as a result of any infringement or alleged infringement of any patent, utility model, registered design, trademark, copyright, or other intellectual property right registered or otherwise existing at the date of the Contract by reason of:

- a) the installation of the Goods by the Supplier or the use of the Goods in the country where the Site is located; and
- b) the sale in any country of the products produced by the Goods.

Such indemnity shall not cover any use of the Goods or any part thereof other than for the purpose indicated by or to be reasonably inferred from the Contract, neither any infringement resulting from the use of the Goods or any part thereof, or any products produced thereby in association or combination with any other equipment, plant, or materials not supplied by the Supplier, pursuant to the Contract.

- 292 If any proceedings are brought or any claim is made against the Procuring Entity arising out of the matters referred to in GCC Sub-Clause 29.1, the Procuring Entity shall promptly give the Supplier a notice thereof, and the Supplier may at its own expense and in the Procuring Entity's name conduct such proceedings or claim and any negotiations for the settlement of any such proceedings or claim.
- 293 If the Supplier fails to notify the Procuring Entity within twenty-eight (28) days after receipt of such notice that it intends to conduct any such proceedings or claim, then the Procuring Entity shall be free to conduct the same on its own behalf.
- 294 The Procuring Entity shall, at the Supplier's request, afford all available assistance to the Supplier in conducting such proceedings or claim, and shall be reimbursed by the Supplier for all reasonable expenses incurred in so doing.
- 295 The Procuring Entity shall indemnify and hold harmless the Supplier and its employees, officers, and Subcontractors from and against any and all suits, actions or administrative proceedings, claims, demands, losses, damages, costs, and expenses of any nature, including attorney's fees and expenses, which the Supplier may suffer as a result of any infringement or alleged infringement of any patent, utility model, registered design, trademark, copyright, or other intellectual property right registered or otherwise existing at the date of the Contract arising out of or in connection with any design, data, drawing, specification, or other documents or materials provided or designed by or on behalf of the Procuring Entity.

30. Limitation of Liability

- 30.1 Except in cases of criminal negligence or willful misconduct,
- a) the Supplier shall not be liable to the Procuring Entity, whether in contract, tort, or otherwise, for any indirect or consequential loss or damage, loss of use, loss of production, or loss of profits or interest costs, provided that this exclusion shall not apply to any obligation of the Supplier to pay liquidated damages to the Procuring Entity, and
 - b) the aggregate liability of the Supplier to the Procuring Entity, whether under the Contract, in tort or otherwise, shall not exceed the total Contract Price, provided that this limitation shall not apply to the cost of repairing or replacing defective equipment, or to any obligation of the supplier to indemnify the Procuring Entity with respect to patent infringement.

31. Change in Laws and Regulations

- 31.1 Unless otherwise specified in the Contract, if after the date of 30 days prior to date of Tender submission, any law, regulation, ordinance, order or bylaw having the force of law is enacted, promulgated, abrogated, or changed in Kenya (which shall be deemed to include any change in interpretation or application by the competent authorities) that subsequently affects the Delivery Date and/or the Contract Price, then such Delivery Date and/or Contract Price shall be correspondingly increased or decreased, to the extent that the Supplier has thereby been affected in the performance of any of its obligations under the Contract. Notwithstanding the foregoing, such additional or reduced cost shall not be separately paid or credited if the same has already been accounted for in the price adjustment provisions where applicable, in accordance with GCC Clause 15.

32. Force Majeure

- 32.1 The Supplier shall not be liable for forfeiture of its Performance Security, liquidated damages, or termination for default if and to the extent that its delay in performance or other failure to perform its obligations under the Contract is the result of an event of Force Majeure.
- 32.2 For purposes of this Clause, "Force Majeure" means an event or situation beyond the control of the Supplier that is not foreseeable, is unavoidable, and its origin is not due to negligence or lack of care on the part of the Supplier. Such events may include, but not be limited to, acts of the Procuring Entity in its sovereign capacity, wars or revolutions,

fires, floods, epidemics, quarantine restrictions, and freight embargoes.

- 323 If a Force Majeure situation arises, the Supplier shall promptly notify the Procuring Entity in writing of such condition and the cause thereof. Unless otherwise directed by the Procuring Entity in writing, the Supplier shall continue to perform its obligations under the Contract as far as is reasonably practical, and shall seek all reasonable alternative means for performance not prevented by the Force Majeure event.

33. Change Orders and Contract Amendments

- 33.1 The Procuring Entity may at any time order the Supplier through notice in accordance GCC Clause 8, to make changes within the general scope of the Contract in any one or more of the following:

- a) drawings, designs, or specifications, where Goods to be furnished under the Contract are to be specifically manufactured for the Procuring Entity;
- b) the method of shipment or packing;
- c) the place of delivery; and
- d) the Related Services to be provided by the Supplier.

- 332 If any such change causes an increase or decrease in the cost of, or the time required for, the Supplier's performance of any provisions under the Contract, an equitable adjustment shall be made in the Contract Price or in the Delivery/Completion Schedule, or both, and the Contract shall accordingly be amended. Any claims by the Supplier for adjustment under this Clause must be asserted within twenty-eight (28) days from the date of the Supplier's receipt of the Procuring Entity's change order.

- 333 Prices to be charged by the Supplier for any Related Services that might be needed but which were not included in the Contract shall be agreed upon in advance by the parties and shall not exceed the prevailing rates charged to other parties by the Supplier for similar services.

- 334 **Value Engineering:** The Supplier may prepare, at its own cost, a value engineering proposal at any time during the performance of the contract. The value engineering proposal shall, at a minimum, include the following;

- a) the proposed change(s), and a description of the difference to the existing contract requirements;
- b) a full cost/benefit analysis of the proposed change(s) including a description and estimate of costs (including life cycle costs) the Procuring Entity may incur in implementing the value engineering proposal; and
- c) a description of any effect(s) of the change on performance/functionality.

- 335 The Procuring Entity may accept the value engineering proposal if the proposal demonstrates benefits that:

- a) accelerates the delivery period; or
- b) reduces the Contract Price or the life cycle costs to the Procuring Entity; or
- c) improves the quality, efficiency or sustainability of the Goods; or
- d) yields any other benefits to the Procuring Entity, without compromising the necessary functions of the Facilities.

- 336 If the value engineering proposal is approved by the Procuring Entity and results in:

- a) a reduction of the Contract Price; the amount to be paid to the Supplier shall be the percentage specified **in the SCC** of the reduction in the Contract Price; or
- b) an increase in the Contract Price; but results in a reduction in life cycle costs due to any benefit described in
(a) to (d) above, the amount to be paid to the Supplier shall be the full increase in the Contract Price.

33.7 Subject to the above, no variation in or modification of the terms of the Contract shall be made except by written amendment signed by the parties.

34. Extensions of Time

34.1 If at any time during performance of the Contract, the Supplier or its subcontractors should encounter conditions impeding timely delivery of the Goods or completion of Related Services pursuant to GCC Clause 13, the Supplier shall promptly notify the Procuring Entity in writing of the delay, its likely duration, and its cause. As soon as practicable after receipt of the Supplier's notice, the Procuring Entity shall evaluate the situation and may at its discretion extend the Supplier's time for performance, in which case the extension shall be ratified by the parties by amendment of the Contract.

34.2 Except in case of Force Majeure, as provided under GCC Clause 32, a delay by the Supplier in the performance of its Delivery and Completion obligations shall render the Supplier liable to the imposition of liquidated damages pursuant to GCC Clause 26, unless an extension of time is agreed upon, pursuant to GCC Sub-Clause 34.1.

35. Termination

35.1 Termination for Default

- a) The Procuring Entity, without prejudice to any other remedy for breach of Contract, by written notice of default sent to the Supplier, may terminate the Contract in whole or in part:
 - i) if the Supplier fails to deliver any or all of the Goods within the period specified in the Contract, or within any extension thereof granted by the Procuring Entity pursuant to GCC Clause 34;
 - ii) if the Supplier fails to perform any other obligation under the Contract; or
 - iii) if the Supplier, in the judgment of the Procuring Entity has engaged in Fraud and Corruption, as defined in paragraph 2.2 a of the Appendix to the GCC, in competing for or in executing the Contract.
- b) In the event the Procuring Entity terminates the Contract in whole or in part, pursuant to GCC Clause 35.1(a), the Procuring Entity may procure, upon such terms and in such manner as it deems appropriate, Goods or Related Services similar to those undelivered or not performed, and the Supplier shall be liable to the Procuring Entity for any additional costs for such similar Goods or Related Services. However, the Supplier shall continue performance of the Contract to the extent not terminated.

35.2 Termination for Insolvency.

The Procuring Entity may at any time terminate the Contract by giving notice to the Supplier if the Supplier becomes bankrupt or otherwise insolvent. In such event, termination will be without compensation to the Supplier, provided that such termination will not prejudice or affect any right of action or remedy that has accrued or will accrue thereafter to the Procuring Entity

35.2 Termination for Convenience.

- a) The Procuring Entity, by notice sent to the Supplier, may terminate the Contract, in whole or in part, at any time for its convenience. The notice of termination shall specify that termination is for the Procuring Entity's convenience, the extent to which performance of the Supplier under the Contract is terminated, and the date upon which such termination becomes effective.
- b) The Goods that are complete and ready for shipment within twenty-eight (28) days after the Supplier's receipt of notice of termination shall be accepted by the Procuring Entity at the Contract terms and prices. For the remaining Goods, the Procuring Entity may elect:
 - i) to have any portion completed and delivered at the Contract terms and prices; and/or
 - ii) to cancel the remainder and pay to the Supplier an agreed amount for partially completed Goods and Related Services and for materials and parts previously procured by the Supplier.

36. Assignment

36.1 Neither the Procuring Entity nor the Supplier shall assign, in whole or in part, their obligations under this Contract, except with prior written consent of the other party.

37. Export Restriction

37.1 Notwithstanding any obligation under the Contract to complete all export formalities, any export restrictions attributable to the Procuring Entity, to Kenya, or to the use of the products/goods, systems or services to be supplied, which arise from trade regulations from a country supplying those products/goods, systems or services, and which substantially impede the Supplier from meeting its obligations under the Contract, shall release the Supplier from the obligation to provide deliveries or services, always provided, however, that the Supplier can demonstrate to the satisfaction of the Procuring Entity that it has completed all formalities in a timely manner, including applying for permits, authorizations and licenses necessary for the export of the products/goods, systems or services under the terms of the Contract. Termination of the Contract on this basis shall be for the Procuring Entity's convenience pursuant to Sub-Clause 35.3.

SECTION VII - SPECIAL CONDITIONS OF CONTRACT

The following Special Conditions of Contract (SCC) shall supplement and/or amend the General Conditions of Contract (GCC). Whenever there is a conflict, the provisions herein shall prevail over those in the GCC.

Number of GC Clause	Amendments of, and Supplements to, Clauses in the General Conditions of Contract
GCC 1.1(h)	The Procuring Entity is: <i>Kenya Electricity Generating Company PLC</i>
GCC 2.2 (b)	The version edition of Incoterms shall be <i>INCOTERMS 2020</i>
GCC 8.1	For <u>notices</u> , the Procuring Entity's address shall be: Attention: General Manager, Supply Chain Postal address P.O Box 47936 00100 Nairobi, Kenya Physical Address KenGen Pension Plaza II, 9th Floor, Kolobot Road, Parklands. Telephone: 0711036000 Electronic mail address: contracts@kengen.co.ke ;
GCC 10.4.2	The place of arbitration shall be Nairobi, Kenya . (Nairobi Centre for International Arbitration)
GCC 15.1	The prices charged for the Goods supplied and the related Services performed <i>shall not</i> be adjustable.
GCC 16.1	Payment Terms and Conditions Payment shall be thirty (30) days upon delivery, Inspection, and acceptance. Local suppliers shall be paid through Electronic Funds Transfer (EFT). Advance Payment Advance payment is not applicable.
GCC 18.1	A Performance Security shall be required . Performance Security Performance security shall be at 1% of the Contract Price where the contract value is above five million shillings. The performance security shall remain valid for 30 days beyond the validity of the contract.
GCC 18.3	The Performance Security shall be in the form of: an on-Demand Bank Guarantee from a bank registered by Central Bank of Kenya The Performance security shall be denominated in the currency of the contract.
GCC 24.1	The insurance coverage shall be as specified in the Incoterms. The term shall be strictly Delivered and Duty Paid (DDP) to Kipevu Power Station
GCC 25.1	Responsibility for transportation of the Goods shall be as specified in the Incoterms. (DDP Kipevu Power Station)
Framework Contracting terms	N/A
	Contract duration The contract duration shall be Twelve (12) months from the commencement date. The commencement date shall be the date of contract signature or as agreed by both parties in writing.
	Delivery: Delivery period shall be within six (6) months from the contract commencement date.
Prices	Prices shall be quoted inclusive of all applicable taxes .
GCC 26.2	The Inspections and tests shall be conducted at KenGen premise, Kipevu Power Station
GCC 27.1	The liquidated damage shall be: 0.5 % per week.

GCC 27.1	The maximum amount of liquidated damages shall be: 10 %
GCC 28.3	The period of validity of the Warranty shall be: 12 months . For purposes of the Warranty, the place(s) of final destination(s) shall be: (DDP Kipevu Power Station) .
GCC 28.5, GCC 28.6	Rectification period shall be within Four (4) months from defect notification date. The delivery terms shall be to Kipevu Power Station stores
	Governing Language The contract shall be written in the English language. All correspondence and other documents pertaining to the contract, which are exchanged by the parties, shall be written in the same language.
	<p>Taxes</p> <p>a) "Taxes" means all present and future taxes, levies, duties, charges, assessments, deductions or withholdings whatsoever, including any interest thereon, and any penalties and fines with respect thereto, wherever imposed, levied, collected, or withheld pursuant to any regulation having the force of law and "Taxation" shall be construed accordingly.</p> <p>b) Local Taxation</p> <p>i. Nothing in the Contract shall relieve the Contractor and/or his Sub-Contractors from their responsibility to pay any taxes, statutory contributions and levies that may be levied on them in Kenya in respect of the Contract.</p> <p>ii. The Contract Price shall include all applicable taxes and shall not be adjusted for any of these taxes.</p> <p>iii. Tax exemption granted under this Contract shall be for an official aid funded project and shall be as provided under the applicable tax laws in Kenya.</p> <p>iv. The Contractor shall be deemed to be familiar with the tax laws in the Employer's Country and satisfied themselves with the requirements for all taxes, statutory contributions and duties to which they may be subjected during the term of the Contract. This shall include applicable local or foreign withholding tax, excise duty, Value Added Tax (VAT), importation duties, Local government taxes, and any other taxes not mentioned herein.</p> <p>v. In instances where discussions are held between the Employer and the Contractor regarding tax matters, this shall not be deemed to constitute competent advice and hence does not absolve the Contractor of their responsibility in relation to due diligence on the tax issue as per (i).</p> <p>c) Tax Deduction</p> <p>i. If the Employer is required to make a tax deduction by Law, then the deduction shall be made from payments due to the Contractor and paid directly to the Kenya Revenue Authority. The Employer shall upon remitting the tax to Kenya Revenue Authority furnish the Contractor with the relevant tax deduction certificates.</p> <p>ii. Where payments for the Contract Price are made directly by the financiers to the Contractor, the Contractor and the financiers shall make the necessary arrangements with Employer to ensure that withholding income tax is remitted to the Kenya Revenue Authority.</p> <p>d) Tax Indemnity</p> <p>i. The Contractor shall indemnify and hold the Employer harmless from and against any and all tax liabilities, which the Employer may incur for any reason of failure by the Contractor to comply with any tax laws arising from the execution of the Contract whether during the term of the Contract or after its expiry.</p>

	<p>ii. The Contractor warrants to pay the Employer (within fourteen (14) days of demand by the Employer), an amount equal to the loss, liability or cost which the Employer determines has been (directly or indirectly) suffered by the Employer for or on account of the Contractor's Tax liability arising from the Contract.</p>
--	--

	<p>iii. Where the amount in (ii) above remains unpaid after the end of the fourteen (14) days moratorium, the Employer shall be entitled to compensation for financing charges.</p>
--	---

SECTION VIII - CONTRACT FORMS

This Section contains forms which, once completed, will form part of the Contract. The forms for Performance Security and Advance Payment Security, when required, shall only be completed by the successful tenderer after contract award.

FORM No. 1: NOTIFICATION OF INTENTION TO AWARD

This Notification of Intention to Award shall be sent to each Tenderer that submitted a Tender. Send this Notification to the Tenderer's Authorized Representative named in the Tender Information Form on the format below.

FORMAT

1. For the attention of Tenderer's Authorized Representative

i) Name: _____ *[insert Authorized Representative's name]*

ii) Address: _____ *[insert Authorized Representative's Address]*

iii) Telephone: _____ *[insert Authorized Representative's telephone/fax numbers]*

iv) Email Address: _____ *[insert Authorized Representative's email address]*

[IMPORTANT: insert the date that this Notification is transmitted to Tenderers. The Notification must be sent to all Tenderers simultaneously. This means on the same date and as close to the same time as possible.]

2. Date of transmission: _____ *[email]* on *[date]* _____ (local time)

This Notification is sent by _____ *(Name and designation)*

3. Notification of Intention to Award

i) Employer: _____ *[insert the name of the Employer]*

ii) Project: _____ *[insert name of project]*

iii) Contract title: _____ *[insert the name of the contract]*

iv) Country: _____ *[insert country where ITT is issued]*

v) ITT No: _____ *[insert ITT reference number from Procurement Plan]*

This Notification of Intention to Award (Notification) notifies you of our decision to award the above contract. The transmission of this Notification begins the Standstill Period. During the Standstill Period, you may:

4. Request a debriefing in relation to the evaluation of your tender

Submit a Procurement-related Complaint in relation to the decision to award the contract.

a) The successful tenderer

i) Name of successful Tender _____

ii) Address of the successful Tender _____

iii) Contract price of the successful Tender Kenya Shillings _____ (in words _____)

b) Other Tenderers

Names of all Tenderers that submitted a Tender. If the Tender's price was evaluated include

Tender for Supply of Hydraulic Equipment for Kipevu III Power Plant.

the evaluated price as well as the Tender price as read out. For Tenders not evaluated, give one main reason the Tender was unsuccessful.

S/No.	Name of Tender	Tender Price as read out	Tender's evaluated price (Note a)	One Reason Why Not Evaluated
1				
2				
3				
4				
5				

(Note a) State NE if not evaluated

5. How to request a debriefing

- a) DEADLINE: The deadline to request a debriefing expires at midnight on *[insert date]* (local time).
- b) You may request a debriefing in relation to the results of the evaluation of your Tender. If you decide to request a debriefing your written request must be made within three (5) Business Days of receipt of this Notification of Intention to Award.
- c) Provide the contract name, reference number, name of the Tenderer, contact details; and address the request for debriefing as follows:
 - i) Attention: _____ *[insert full name of person, if applicable]*
 - ii) Title/position: _____ *[insert title/position]*
 - ii) Agency: _____ *[insert name of Employer]*
 - iii) Email address: _____ *[insert email address]*
- d) If your request for a debriefing is received within the 3 Days deadline, we will provide the debriefing within five (3) Business Days of receipt of your request. If we are unable to provide the debriefing within this period, the Standstill Period shall be extended by five (3) Days after the date that the debriefing is provided. If this happens, we will notify you and confirm the date that the extended Standstill Period will end.
- e) The debriefing may be in writing, by phone, video conference call or in person. We shall promptly advise you in writing how the debriefing will take place and confirm the date and time.
- f) If the deadline to request a debriefing has expired, you may still request a debriefing. In this case, we will provide the debriefing as soon as practicable, and normally no later than fifteen (15) Days from the date of publication of the Contract Award Notice.

6. How to make a complaint

- a) Period: Procurement-related Complaint challenging the decision to award shall be submitted by midnight, *[insert date]* (local time).
- b) Provide the contract name, reference number, name of the Tenderer, contact details; and address the Procurement-related Complaint as follows:
 - i) Attention: _____ *[insert full name of person, if applicable]*
 - ii) Title/position: _____ *[insert title/position]*
 - iii) Agency: _____ *[insert name of Employer]*
 - iv) Email address: _____ *[insert email address]*

- c) At this point in the procurement process, you may submit a Procurement-related Complaint challenging the decision to award the contract. You do not need to have requested, or received, a debriefing before making this complaint. Your complaint must be submitted within the Standstill Period and received by us before the Standstill Period ends.
- d) Further information: For more information refer to the Public Procurement and Disposals Act 2015 and its Regulations available from the Website www.ppra.go.ke or email complaints@ppra.go.ke.

You should read these documents before preparing and submitting your complaint.

- e) There are four essential requirements:
 - i) You must be an ‘interested party’. In this case, that means a Tenderer who submitted a Tender in this tendering process, and is the recipient of a Notification of Intention to Award.
 - ii) The complaint can only challenge the decision to award the contract.
 - iii) You must submit the complaint within the period stated above.
 - iv) You must include, in your complaint, all of the information required to support your complaint.

7. Standstill Period

- i) DEADLINE: The Standstill Period is due to end at midnight on [*insert date*] (local time).
- ii) The Standstill Period lasts ten (14) Days after the date of transmission of this Notification of Intention to Award.
- iii) The Standstill Period may be extended as stated in paragraph Section 5 (d) above.

If you have any questions regarding this Notification please do not hesitate to contact us.

On behalf of the Employer:

Signature: _____

Name: _____

Title/position: _____

Telephone: _____

Email: _____

FORM FOR REVIEW(r.203(1))

PUBLIC PROCUREMENT ADMINISTRATIVE REVIEW BOARD

APPLICATION NO.....OF.....20.....

BETWEEN

.....APPLICANT

AND

.....RESPONDENT (Procuring Entity)

Request for review of the decision of the..... (Name of the Procuring Entity ofdated the...day of20.....in the matter of Tender No.....of20..... for(Tender description).

REQUEST FOR REVIEW

I/We.....,the above named Applicant(s), of address: Physical address.....P. O. Box No..... Tel. No.....Email, hereby request the Public Procurement Administrative Review Board to review the whole/part of the above mentioned decision on the following grounds , namely:

- 1.
2.

By this memorandum, the Applicant requests the Board for an order/orders that:

- 1.
2.

SIGNED(Applicant) Dated on.....day of/ ...20.....

FOR OFFICIAL USE ONLY Lodged with the Secretary Public Procurement Administrative Review Board on.....day of20.....

SIGNED

Board Secretary

FORM NO. 3 LETTER OF AWARD

[Use letter head paper of the Procuring Entity]

_____ *[Date]*

To: _____ *[name and address of the Supplier]*

Subject: _____ *Notification of Award Contract No.*

This is to notify you that your Tender dated _____ *[insert date]* for execution of the _____ *[insert name of the contract and identification number, as given in the SCC]* for the Accepted Contract Amount of _____ *[insert amount in numbers and words and name of currency]*, as corrected and modified in accordance with the Instructions to tenderers is hereby accepted by our Agency.

You are requested to furnish the Performance Security within 30 days in accordance with the Conditions of Contract, using for that purpose the of the Performance Security Form included in Section X, Contract Forms, of the Tendering document.

Authorized Signature: _____

Name and Title of Signatory: _____

Name of Agency: _____

Attachment: Contract Agreement

FORM NO. 4 - CONTRACT AGREEMENT

[The successful tenderer shall fill in this form in accordance with the instructions indicated]

THIS AGREEMENT made the _____ *[insert: number]* day of _____ *[insert: month]*, *[insert: year]*. BETWEEN (1) _____ *[insert complete name of Procuring Entity]* and having its principal place of business at *[insert: address of Procuring Entity]* (hereinafter called "Procuring Entity"), of the one part; and (2) _____ *[insert name of Supplier]*, a corporation incorporated under the laws of *[insert: country of Supplier]* and having its principal place of business at _____ *[insert: address of Supplier]* (hereinafter called "the Supplier"), of the other part.

1. WHEREAS the Procuring Entity invited Tenders for certain Goods and ancillary services, viz., _____ *[insert brief description of Goods and Services]* and has accepted a Tender by the Supplier for the supply of those Goods and Services, the Procuring Entity and the Supplier agree as follows:
 - i) In this Agreement words and expressions shall have the same meanings as are respectively assigned to them in the Contract documents referred to.
 - ii) The following documents shall be deemed to form and be read and construed as part of this Agreement. This Agreement shall prevail over all other contract documents.
 - a) the Letter of Acceptance
 - b) the Letter of Tender
 - c) the Addenda Nos. ___ (if any)
 - d) Special Conditions of Contract
 - e) General Conditions of Contract
 - f) the Specification (including Schedule of Requirements and Technical Specifications)
 - g) the completed Schedules (including Price Schedules)
 - h) any other document listed in GCC as forming part of the Contract
 - iii) In consideration of the payments to be made by the Procuring Entity to the Supplier as specified in this Agreement, the Supplier hereby covenants with the Procuring Entity to provide the Goods and Services and to remedy defects therein in conformity in all respects with the provisions of the Contract.
2. The Procuring Entity hereby covenants to pay the Supplier in consideration of the provision of the Goods and Services and the remedying of defects therein, the Contract Price or such other sum as may become payable under the provisions of the Contract at the times and in the manner prescribed by the Contract.
3. IN WITNESS whereof the parties hereto have caused this Agreement to be executed in accordance with the laws of Kenya on the day, month and year indicated above.

For and on behalf of the Procuring Entity

Signed: _____ *[insert signature]*

in the capacity of _____ *[insert title or other appropriate designation]* In the presence of _____ *[insert identification of official witness]* **For and on behalf of the**

Supplier

Signed: _____ *[insert signature of authorized representative(s) of the Supplier]* in the capacity of _____ *[insert title or other appropriate designation]* in the presence of

_____ *[insert identification of official witness]*

FORM NO. 5 - PERFORMANCE SECURITY [Option 1 - Unconditional Demand Bank Guarantee]

[Guarantor letterhead]

Beneficiary: _____ [insert name and Address of Employer]

Date: _____ [Insert date of issue]

Guarantor: _____ [Insert name and address of place of issue, unless indicated in the letterhead]

1. We have been informed that _____ (hereinafter called "the Contractor") has entered into Contract No. _____ dated _____ with (name of Employer) _____ (the Employer as the Beneficiary), for the execution of _____ (hereinafter called "the Contract").
2. Furthermore, we understand that, according to the conditions of the Contract, a performance guarantee is required.
3. At the request of the Contractor, we as Guarantor, hereby irrevocably undertake to pay the Beneficiary any sum or sums not exceeding in total an amount of _____ (in words),¹ such sum being payable in the types and proportions of currencies in which the Contract Price is payable, upon receipt by us of the Beneficiary's complying demand supported by the Beneficiary's statement, whether in the demand itself or in a separate signed document accompanying or identifying the demand, stating that the Applicant is in breach of its obligation(s) under the Contract, without the Beneficiary needing to prove or to show grounds for your demand or the sum specified therein.
4. This guarantee shall expire, no later than the Day of, 2.....², and any demand for payment under it must be received by us at the office indicated above on or before that date.
5. The Guarantor agrees to a one-time extension of this guarantee for a period not to exceed [six months] [one year], in response to the Beneficiary's written request for such extension, such request to be presented to the Guarantor before the expiry of the guarantee."

[Name of Authorized Official, signature(s) and seals/stamps]

FORM No. 6 - PERFORMANCE SECURITY [Option 2- Performance Bond]

[Note: Procuring Entities are advised to use Performance Security – Unconditional Demand Bank Guarantee instead of Performance Bond due to difficulties involved in calling Bond holder to action]

[Guarantor letterhead or SWIFT identifier code]

Beneficiary: _____ *[insert name and Address of Employer]*
Date: _____ *[Insert date of issue]*

PERFORMANCE BOND No.: _____

Guarantor: _____ *[Insert name and address of place of issue, unless indicated in the letterhead]*

1. By this Bond _____ as Principal (hereinafter called “the Contractor”) and _____ as Surety (hereinafter called “the Surety”), are held and firmly bound unto _____ as Obligee (hereinafter called “the Employer”) in the amount of _____ for the payment of which sum well and truly to be made in the types and proportions of currencies in which the Contract Price is payable, the Contractor and the Surety bind themselves, their heirs, executors, administrators, successors and assigns, jointly and severally, firmly by these presents.
2. WHEREAS the Contractor has entered into a written Agreement with the Employer dated the _____ day of _____, 20_____, for _____ in accordance with the documents, plans, specifications, and amendments thereto, which to the extent herein provided for, are by reference made part hereof and are hereinafter referred to as the Contract.
3. NOW, THEREFORE, the Condition of this Obligation is such that, if the Contractor shall promptly and faithfully perform the said Contract (including any amendments thereto), then this obligation shall be null and void; otherwise, it shall remain in full force and effect. Whenever the Contractor shall be, and declared by the Employer to be, in default under the Contract, the Employer having performed the Employer's obligations thereunder, the Surety may promptly remedy the default, or shall promptly:
 - 1) complete the Contract in accordance with its terms and conditions; or
 - 2) obtain a tender or tenders from qualified tenderers for submission to the Employer for completing the Contract in accordance with its terms and conditions, and upon determination by the Employer and the Surety of the lowest responsive Tenderers, arrange for a Contract between such Tenderer, and Employer and make available as work progresses (even though there should be a default or a succession of defaults under the Contract or Contracts of completion arranged under this paragraph) sufficient funds to pay the cost of completion less the Balance of the Contract Price; but not exceeding, including other costs and damages for which the Surety may be liable hereunder, the amount set forth in the first paragraph hereof. The term “Balance of the Contract Price,” as used in this paragraph, shall mean the total amount payable by Employer to Contractor under the Contract, less the amount properly paid by Employer to Contractor; or
 - 3) pay the Employer the amount required by Employer to complete the Contract in accordance with its terms and conditions up to a total not exceeding the amount of this Bond.
4. The Surety shall not be liable for a greater sum than the specified penalty of this Bond.
5. Any suit under this Bond must be instituted before the expiration of one year from the date of the issuing of the Taking-Over Certificate. No right of action shall accrue on this

Bond to or for the use of any person or corporation other than the Employer named herein or the heirs, executors, administrators, successors, and assigns of the Employer.

6. In testimony whereof, the Contractor has hereunto set his hand and affixed his seal, and the Surety has caused these presents to be sealed with his corporate seal duly attested by the signature of his legal representative, this day _____ of _____ 20_____.

SIGNED ON _____ on behalf of _____

By _____ in the capacity of _____

In the presence of _____

SIGNED ON _____ on behalf of _____

By _____ in the capacity of _____

In the presence of _____

FORM NO. 7 - ADVANCE PAYMENT SECURITY [Demand Bank Guarantee]

[Guarantor letterhead]

Beneficiary: _____ *[Insert name and Address of Employer]*

Date: _____ *[Insert date of issue]*

ADVANCE PAYMENT GUARANTEE No.: _____ *[Insert guarantee reference number]*

Guarantor: *[Insert name and address of place of issue, unless indicated in the letterhead]*

1. We have been informed that _____ (hereinafter called "the Contractor") has entered into Contract No. _____ dated _____ with the Beneficiary, for the execution of _____ (hereinafter called "the Contract").

2. Furthermore, we understand that, according to the conditions of the Contract, an advance payment in the sum _____ (*in words* _____) is to be made against an advance payment guarantee.

3. At the request of the Contractor, we as Guarantor, hereby irrevocably undertake to pay the Beneficiary any sum or sums not exceeding in total an amount of _____ (*in words* _____) ¹ upon receipt by us of the Beneficiary's complying demand supported by the Beneficiary's statement, whether in the demand itself or in a separate signed document accompanying or identifying the demand, stating either that the Applicant:

(a) has used the advance payment for purposes other than the costs of mobilization in respect of the goods; or

(b) has failed to repay the advance payment in accordance with the Contract conditions, specifying the amount which the Applicant has failed to repay.

4. A demand under this guarantee may be presented as from the presentation to the Guarantor of a certificate from the Beneficiary's bank stating that the advance payment referred to above has been credited to the Contractor on its account number _____ at _____.

5. The maximum amount of this guarantee shall be progressively reduced by the amount of the advance payment repaid by the Contractor as specified in copies of interim statements or payment certificates which shall be presented to us. This guarantee shall expire, at the latest, upon our receipt of a copy of the interim payment certificate indicating that ninety (90) percent of the Accepted Contract Amount, less provisional sums, has been certified for payment, or on the ___ day of _____, 2____, ² whichever is earlier. Consequently, any demand for payment under this guarantee must be received by us at this office on or before that date.

6. The Guarantor agrees to a one-time extension of this guarantee for a period not to exceed *[six months/one year]*, in response to the Beneficiary's written request for such extension, such request to be presented to the Guarantor before the expiry of the guarantee.

[Name of Authorized Official, signature(s) and seals/stamps]

¹The Guarantor shall insert an amount representing the amount of the advance payment and denominated either in the currency of the advance payment as specified in the Contract.

² Insert the expected expiration date of the Time for Completion. The Employer should note that in the event of an extension of the time for completion of the Contract, the Employer would need to request an extension of this guarantee from the Guarantor. Such request must be in writing and must be made prior to the expiration date established in the guarantee.

FORM NO. 8 - RETENTION MONEY SECURITY

1.1.7 [Demand Bank Guarantee]

[Guarantor letterhead]

Beneficiary: _____ [Insert name and Address of Procuring Entity]

Date: _____ [Insert date of issue]

Advance payment guarantee no. [Insert guarantee reference number]

Guarantor: [Insert name and address of place of issue, unless indicated in the letterhead]

1. We have been informed that _____ [insert name of Contractor, which in the case of a joint venture shall be the name of the joint venture] (hereinafter called "the Contractor") has entered into Contract No. _____ [insert reference number of the contract] dated _____ with _____ the Beneficiary, for the execution of _____ [insert name of contract and brief description of Works] (hereinafter called "the Contract").
2. Furthermore, we understand that, according to the conditions of the Contract, the Beneficiary retains moneys up to the limit set forth in the Contract ("the Retention Money"), and that when the Taking-Over Certificate has been issued under the Contract and the first half of the Retention Money has been certified for payment, and payment of [insert the second half of the Retention Money] is to be made against a Retention Money guarantee.
3. At the request of the Contractor, we, as Guarantor, hereby irrevocably undertake to pay the Beneficiary any sum or sums not exceeding in total an amount of [insert amount in figures] _____ ([insert amount in words _____])¹ upon receipt by us of the Beneficiary's complying demand supported by the Beneficiary's statement, whether in the demand itself or in a separate signed document accompanying or identifying the demand, stating that the Contractor is in breach of its obligation(s) under the Contract, without your needing to prove or show grounds for your demand or the sum specified therein.
4. A demand under this guarantee may be presented as from the presentation to the Guarantor of a certificate from the Beneficiary's bank stating that the second half of the Retention Money as referred to above has been credited to the Contractor on its account number _____ at _____ [insert name and address of Applicant's bank].
5. This guarantee shall expire no later than the Day of, 2.....², and any demand for payment under it must be received by us at the office indicated above on or before that date.
6. The Guarantor agrees to a one-time extension of this guarantee for a period not to exceed [six months] [one year], in response to the Beneficiary's written request for such extension, such request to be presented to the Guarantor before the expiry of the guarantee.

[Name of Authorized Official, signature(s) and seals/stamps]

1

FORM NO. 9 BENEFICIAL OWNERSHIP DISCLOSURE FORM

(Amended and issued pursuant to PPRA CIRCULAR No. 02/2022)

INSTRUCTIONS TO TENDERERS: DELETE THIS BOX ONCE YOU HAVE COMPLETED THE FORM

This Beneficial Ownership Disclosure Form (“Form”) is to be completed by the successful tenderer pursuant to Regulation 13 (2A) and 13 (6) of the Companies (Beneficial Ownership Information) Regulations, 2020. In case of joint venture, the tenderer must submit a separate Form for each member. The beneficial ownership information to be submitted in this Form shall be current as of the date of its submission.

For the purposes of this Form, a Beneficial Owner of a Tenderer is any natural person who ultimately owns or controls the legal person (tenderer) or arrangements or a natural person on whose behalf a transaction is conducted, and includes those persons who exercise ultimate effective control over a legal person (Tenderer) or arrangement.

Tender Reference No.: _____ [insert identification no] Name of the Tender Title/Description: _____ [insert name of the assignment] to: _____ [insert complete name of Procuring Entity]

In response to the requirement in your notification of award dated _____ [insert date of notification of award] to furnish additional information on beneficial ownership: _____ [select one option as applicable and delete the options that are not applicable]

I) We here by provide the following beneficial ownership information.

Details of beneficial ownership

	Details of all Beneficial Owners		% of shares a person holds in the company Directly or indirectly	% of voting rights a person holds in the company	Whether a person directly or indirectly holds a right to appoint or remove a member of the board of directors of the company or an equivalent governing body of the Tenderer (Yes / No)	Whether a person directly or indirectly exercises significant influence or control over the Company (tenderer) (Yes / No)
1.	Full Name		Directly-- ----- % of shares	Directly.....% of voting rights	1. Having the right to appoint a majority of the board of the directors or an equivalent governing body of the Tenderer: Yes -----No----- 2. Is this right held directly or indirectly?: Direct.....	1. Exercise s significant influence or control over the Company body of the Company (tenderer) Yes -----No--- - 2. Is this influence or control exercised directly or indirectly?
	National identity card number or Passport number			Indirectly---- -----% of voting rights		
	Personal Identification Number (where applicable)		Indirectly- ----- % of shares			
	Nationality					
	Date of birth [dd/mm/yyyy]					
	Postal address					
	Residential address					

Details of all Beneficial Owners		% of shares a person holds in the company Directly or indirectly	% of voting rights a person holds in the company	Whether a person directly or indirectly holds a right to appoint or remove a member of the board of directors of the company or an equivalent governing body of the Tenderer (Yes / No)	Whether a person directly or indirectly exercises significant influence or control over the Company (tenderer) (Yes / No)
Telephone number				Indirect.....	Direct.....
Email address			
Occupation or profession					Indirect.....
					...
2.	Full Name	Directly-- ----- % of shares	Directly.....% of voting rights	1. Having the right to appoint a majority of the board of the directors or an equivalent governing body of the Tenderer: Yes -----No-----	1. Exercise s significant influence or control over the Company body of the Company (tenderer) Yes -----No-- --
	National identity card number or Passport number		Indirectly---- -----% of voting rights	2. Is this right held directly or indirectly?:	2. Is this influence or control exercised directly or indirectly?
	Personal Identification Number (where applicable)	Indirectly- ----- % of shares		Direct.....	Direct..... ..
	Nationality(ies)			Indirect.....	Indirect..... ...
	Date of birth [dd/mm/yyyy]				
	Postal address				
	Residential address				
	Telephone number				
	Email address				
	Occupation or profession				
3.					
e.t.					
c					

II) Am fully aware that beneficial ownership information above shall be reported to the Public Procurement Regulatory Authority together with other details in relation to contract awards and shall be maintained in the Government Portal, published and made publicly available pursuant to Regulation 13(5) of the Companies (Beneficial Ownership Information)

Regulations, 2020. (Notwithstanding this paragraph Personally Identifiable Information in line with the Data Protection Act shall not be published or made public). *Note that Personally Identifiable Information (PII) is defined as any information that can be used to distinguish one person from another and can be used to deanonymize previously anonymous data. This information includes National identity card number or Passport number, Personal Identification Number, Date of birth, Residential address, email address and Telephone number.*

III) In determining who meets the threshold of who a beneficial owner is, the Tenderer must consider a natural person who in relation to the company:

- (a) holds at least ten percent of the issued shares in the company either directly or indirectly;
- (b) exercises at least ten percent of the voting rights in the company either directly or indirectly;
- (c) holds a right, directly or indirectly, to appoint or remove a director of the company; or
- (d) exercises significant influence or control, directly or indirectly, over the company.

IV) What is stated to herein above is true to the best of my knowledge, information and belief.

Name of the Tenderer:[insert complete name of the Tenderer]_____*

*Name of the person duly authorized to sign the Tender on behalf of the Tenderer: ** [insert complete name of person duly authorized to sign the Tender]*

Designation of the person signing the Tender: [insert complete title of the person signing the Tender]

Signature of the person named above: [insert signature of person whose name and capacity are shown above]

Date this [insert date of signing] day of..... [Insert month], [insert year]

Bidder Official Stamp